



System Operating Manual

For use with the
Abbott Ambulatory Infusion Manager
List 13967-04



ABBOTT LABORATORIES, NORTH CHICAGO, IL 60064, USA

430-600059-001 (Rev. 2/96)



Discount

CARDIOLOGY

www.discountcardiology.com

www.discountcardiology.com

Abbott AIM[®] Plus

System Operating Manual

**For use with the
Abbott Ambulatory Infusion Manager Plus
List 13967**

This manual is designed for use by healthcare professionals, caregivers, and patients. The Abbott Clinical Customer Support hotline is available 24 hours a day to provide consultation and technical assistance regarding the Abbott AIM Plus.

**Abbott Clinical Customer Support
1-800-338-7867**

**To order additional copies of this manual
(List No. 13032-01) call 1-800-ABBOTT3**

Change History

<i>Part Number</i>	<i>Description of Change</i>	<i>Pages Changed</i>
430-600059-001	Original issue (Rev. 2/96)	

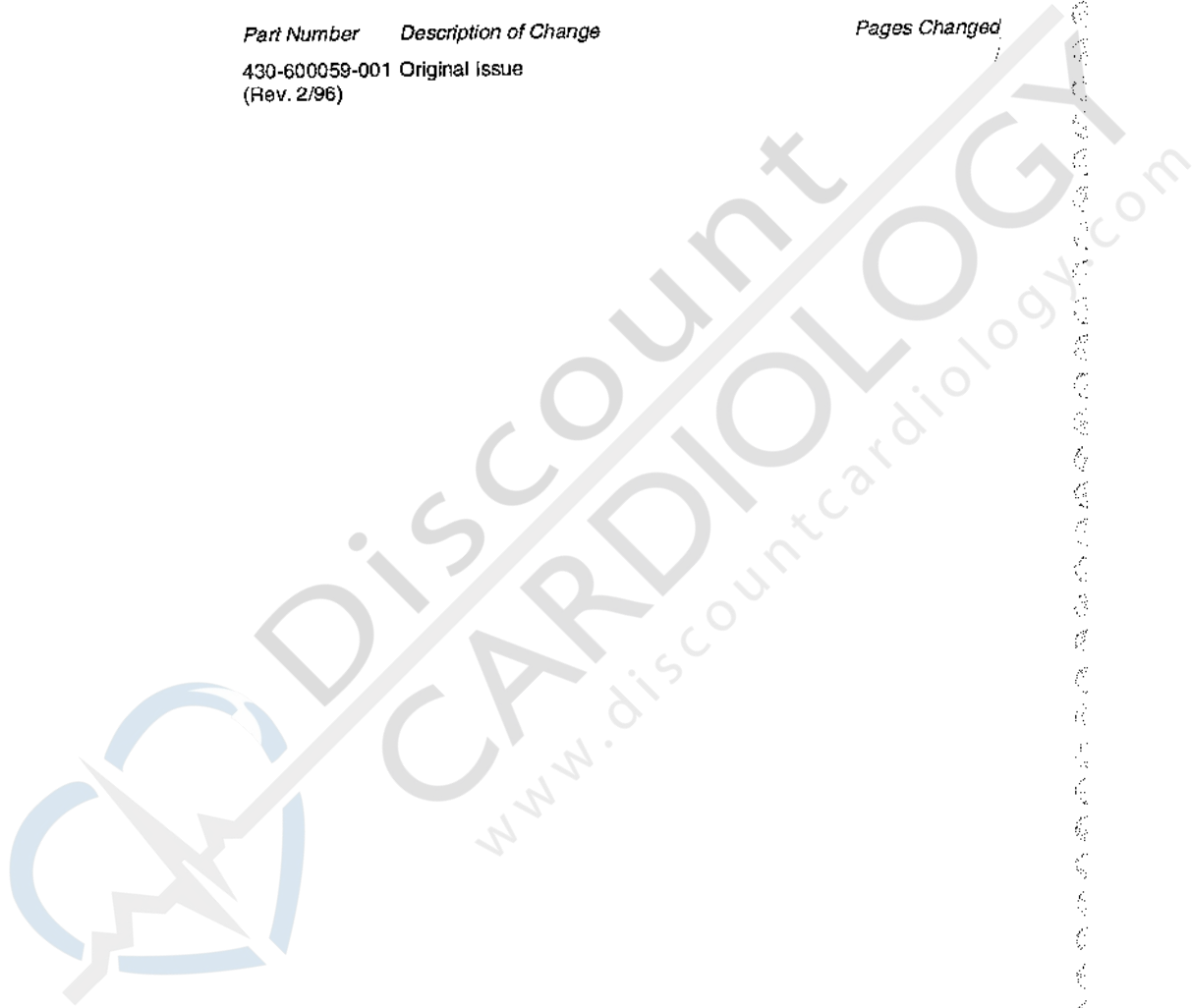

Contents

1 Introduction	1-1
Operating Components	1-2
The Abbott Quick-Load™ Set	1-4
Abbott AIM Plus Accessories	1-6
Indications for Use	1-7
Contraindications for Use	1-8
Clinician Specific Information	1-8
Warnings and Cautions	1-9
2 Basics	2-1
Power Source(s) and Bolus Cord Setup	2-1
Installing Disposable Batteries	2-1
Installing the Battery Pack	2-2
Connecting the AC Power Supply	2-3
Connecting the Bolus Cord	2-3
Cartridge Set and Container Setup	2-4
Preparing the Cartridge Set and Container	2-4
Gravity Priming the Set	2-5
Attaching the Anti-Siphon Valve Extension Set	2-6
Loading the Cartridge	2-7
Powering On the Pump	2-8
Entering a New Program	2-9
Clearing the Previous Therapy	2-10
Choosing a Therapy	2-10
Priming the System	2-11
Starting Delivery	2-12
Stopping Delivery	2-12
Powering Off the Pump	2-12
3 TPN	3-1
Programming Tips	3-1
Programming Steps	3-2
Stop Mode	3-5

Run Mode	3-5
End of Infusion Alert	3-5
TPN Auto Tapering Down	3-6
4 Pain Management	4-1
Programming Tips	4-1
Programming Steps	4-2
Stop Mode	4-6
Run Mode	4-6
Bolus Dose Delivery	4-7
Starting a Bolus Dose Delivery	4-7
Stopping a Bolus Dose Delivery	4-8
Completing a Bolus Dose Delivery after an Empty Container Alarm	4-8
Loading Dose Delivery	4-9
Clinician Activated Loading Dose	4-10
5 Intermittent	5-1
Programming Tips	5-1
Programming Steps	5-2
Stop Mode	5-7
Run Mode	5-7
End of Infusion Alert	5-7
Intermittent Delivery Interruptions	5-8
6 Variable Time	6-1
Programming Tips	6-1
Programming Steps	6-2
Stop Mode	6-9
Run Mode	6-9
Bolus Dose Delivery	6-10
Starting a Bolus Dose Delivery	6-10
Stopping a Bolus Dose Delivery	6-10
Completing a Bolus Dose Delivery after an Empty Container Alarm	6-11
Variable Time Delivery Interruptions	6-11

7 Continuous 7-1

Programming Tips	7-1
Programming Steps	7-2
Stop Mode	7-4
Run Mode	7-4

8 Change and Options Menus 8-1

The Change Menu	8-1
Function 1: Review/Resume	8-1
Function 2: New Container	8-2
TPN Therapy Information	8-3
Intermittent Therapy Information	8-3
Variable Time Therapy Information	8-3
Function 3: New Program	8-4
Function 4: Change Program	8-5
The Options Menu	8-7
Function 1: Review Program	8-7
Function 2: History	8-8
Displaying the History	8-8
Printing the History	8-8
Clearing the History	8-9
Function 3: Keypad Lock	8-10
Locking the Keypad	8-11
Unlocking the Keypad	8-12
Function 4: Air Sensor	8-13
Function 5: Set Clock	8-14
Displaying the Time and Date	8-14
Setting the Clock	8-14
Function 6: Print	8-15
Using a Printer	8-16
Downloading to a PC	8-18
Function 7: Speed Protocol	8-19
Assigning Speed Protocols	8-19
Recalling Speed Protocols	8-20
Reviewing Speed Protocols	8-20
Deleting Speed Protocols	8-21
Function 8: Adjustments	8-22
Adjusting the Sound Level	8-22
Varying the Contrast	8-23

Function 9: Alarm Log	8-24
Displaying the Alarm Log	8-24
Printing the Alarm Log	8-24
9 Troubleshooting	9-1
Customer Support	9-1
Alert Messages	9-2
Alarms	9-4
Troubleshooting Problems and Solutions	9-10
10 Maintenance	10-1
Battery Pack Recharging	10-1
Storing the Pump	10-1
Cleaning and Disinfecting the Pump	10-2
Recommended Cleaning Solutions	10-2
Cleaning the Pump Case	10-3
Cleaning the Cartridge Channel	10-3
Repair	10-4
11 Specifications	11-1
Pump Specifications	11-1
Program Specifications	11-3
12 Warranty	12-1
13 Installation Test	13-1
Physical Inspection	13-1
Operation Verification	13-2
Abbott AIM® Plus Installation Test Record	13-6

Introduction

The Abbott Ambulatory Infusion Manager Plus (Abbott AIM® Plus) is a single-channel infusion device intended for hospital and homecare use. Small and light-weight, the battery powered pump can be placed in a carrying case with fluid for ambulatory patients, or attached to AC power for bedside use.

Five types of programming options are available for flexible delivery of medications and nutritional fluids:

- Total Parenteral Nutrition (TPN)
- Pain Management
- Intermittent
- Variable Time
- Continuous

To begin, you choose the type of therapy for a protocol, then the pump leads you through a series of screens that request protocol information specific to the therapy selected. You will use the keypad to input data and answer questions.

While programming or during alert and alarm conditions, the [HELP] key allows you to access information about the current screen and tips for responding to the screen.

The Abbott AIM Plus infuses in three units of delivery:

- milliliters (mL)
- milligrams (mg)
- micrograms (μ g)

KVO (Keep Vein Open) programming is available for TPN, Intermittent, and Variable Time therapies.

When a container is changed, a program may be repeated without reprogramming by reviewing the program and starting the Abbott AIM Plus again. Nine frequently used programs can be stored in the pump's memory as speed protocols for easy programming.

Bolus doses can be programmed for Pain Management and Variable Time therapies. You can control bolus dose delivery by a time limit combined with an optional dose limit.

For protocols with programmed bolus doses, you may deliver doses by pressing the bolus button on the pump or by pressing the button on the bolus cord (available as an accessory).

The Abbott AIM Plus pump contains a real-time clock that can be used for timed delivery of Intermittent and Variable Time therapies.

For all therapies, the pump maintains a timed history of each event (for example, bolus requests made and delivered) and any alarms that may occur. You can review this history on the display screen and it may be downloaded to a printer or personal computer to create a permanent record.

Safety features include built-in alerts and alarms for an improperly installed cartridge, air or occlusion in the line, low volume, low power, and device malfunction.

For a complete list of alerts and alarms and possible remedies, go to *Section 9, Troubleshooting*. The [HELP] key allows you to display information about an occurring alarm condition.

Operating Components

The following figure shows the Abbott AIM Plus and briefly describes the pump's operating controls and accessory ports.

- HELP**
- Access information for programming steps and alarm conditions
- START**
- Start infusion
- STOP**
- Stop Infusion
- OPTIONS**
- Access these menu items:
- 1 Review Program
 - 2 History
 - 3 Keypad Lock
 - 4 Air Sensor
 - 5 Set Clock
 - 6 Print
 - 7 Speed Protocol
 - 8 Adjustments
 - 9 Alarm Log
- SILENCE**
- Temporarily silence alarms
- CHANGE**
- Correct an entry during a programming step
 - Access these menu items from STOP mode:
- 1 Review/Resume
 - 2 New Container
 - 3 New Program
 - 4 Change Program
- BACK-UP**
- Exit Help, Change and Options
 - Access previous steps during programming
- UP and DOWN arrows**
- Scroll through menu selections and pump history
 - Scroll through input selections within programming steps
 - Enter decimal point in numeric entries with UP arrow
- PRIME**
- Prime air from delivery set
- NO**
- Respond "NO" to program questions
- YES/ENTER**
- Respond "YES" to program questions
 - Register numeric entries and advance to next screen

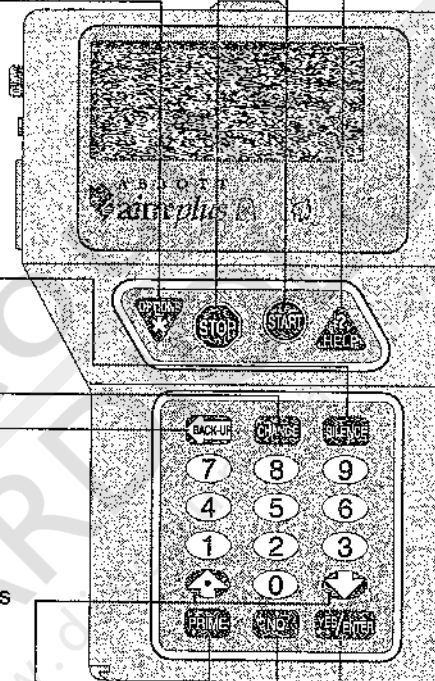

The Abbott Quick-Load™ Set

The Abbott AIM Plus can be operated with an Abbott Quick-Load™ set (e.g., List No. 13403), which is a sterile, single-use, disposable set.

Contact an Abbott Laboratories Representative for appropriate set configuration. The minimum elements required for use with the Abbott AIM Plus include one of each of the following:

- Non-vented, collapsible fluid container
- Abbott Quick-Load set
- Patient access device

Accessories such as air eliminating filters and extension sets may be added to the line as required by the therapy. To use an Abbott Quick-Load set, follow directions included with the set.

The three main parts of the Quick-Load cartridge and their functions are as follows:

- **Rotor** The rotor is the white, ribbed control knob that connects the cartridge to the pump's motor shaft.
- **Red Arrow and Circle** The red arrow on top of the cartridge indicates the rotation direction of the rotor. The red circle and parallel lines indicate whether the fluid path is opened or closed. When the hole on the rotor is between the parallel lines, the fluid path is open. When the hole in the rotor is inside the red circle, the fluid path is closed.
- **Alarm Sensors** The section of the cartridge covered with blue foil contains alarm sensing chambers that are used in the detection of air or occlusions. Occlusion is a blockage in the tubing between the patient and the pump, such as a closed side clamp or kinked tubing, that causes pressure to build in the line below the cartridge.

Note: Occlusions are not detected proximal to the cartridge.

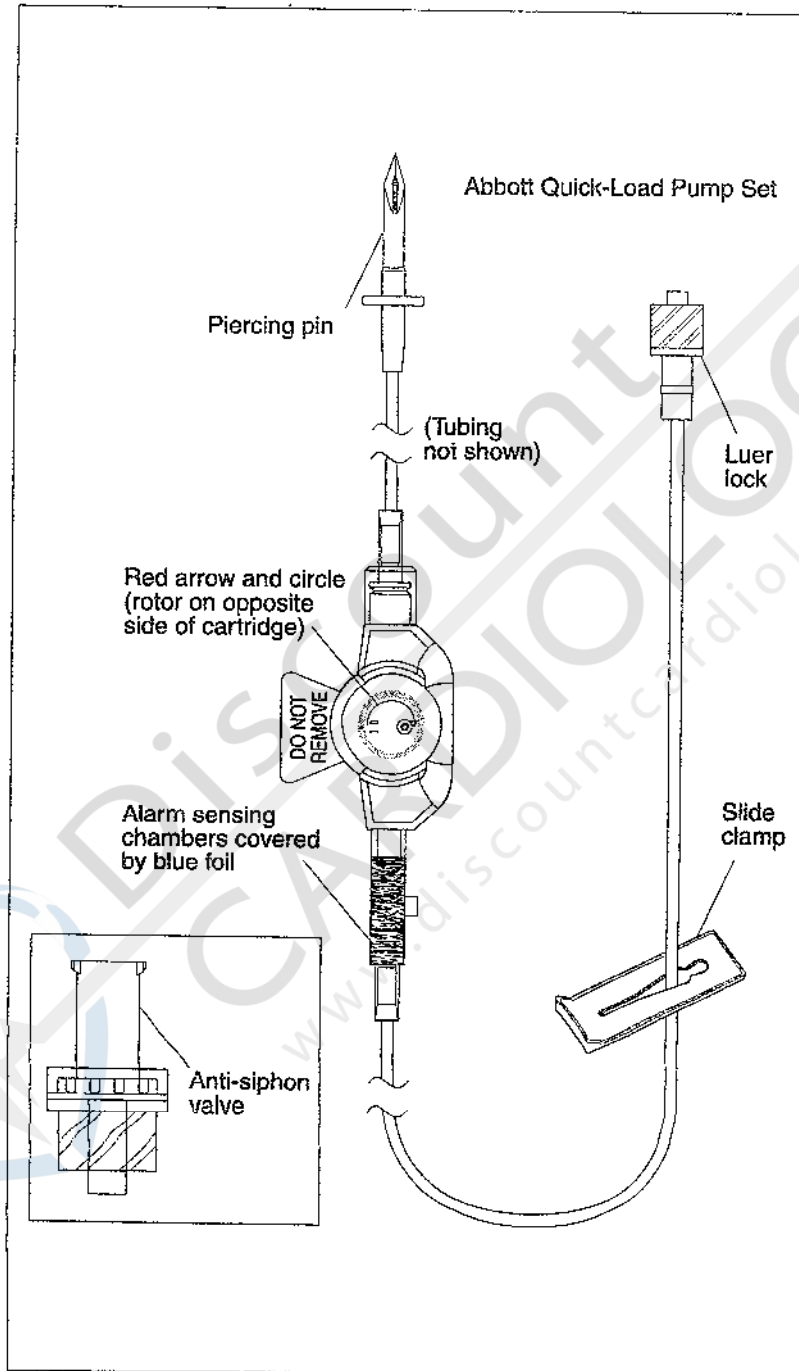

Abbott AIM Plus Accessories

Accessory	List #	Description
AC Power Supply	13586	Powers the Abbott AIM Plus or recharges the Battery Pack. A locking connector keeps the power supply secured to the pump. Do not use the power supply with other products.
Bolus Cord	13587	Allows bolus requests to be made up to 6 feet away from the pump. A locking connector keeps the pendant secured to the pump.
Battery Pack	13588	Powers the Abbott AIM Plus during periods of ambulation or when use of AC power is not desirable.
Printer Cables	13591 13592	Allows the event history, program, speed protocols, and alarm log to be printed or downloaded to file. Use 13591 for a Seiko® DPU411 printer. Use 13592 for a Kodak Diconix® 150+ or 180si printer, or connection to a personal computer.
Transport Case	13255	Hard plastic case that carries the Abbott AIM Plus, two rechargeable Battery Packs, an AC Power Supply, and a Bolus Cord.
Carrier (3-L Bag Support)	13590	Supports up to a 3-L bag of solution and the Abbott AIM Plus with batteries or battery pack installed.
Large Carrying Case (Carrier 13590 included with case)	13593	Soft-sided bag that carries 3-L or smaller container of solution and the Abbott AIM Plus with batteries or battery pack installed supported by the Carrier.
Small Carrying Case	13594	Soft-sided bag that carries a 500-mL or smaller container of solution and the Abbott AIM Plus with disposable batteries installed.

Indications for Use

Physicians or certified, licensed healthcare professionals should always oversee therapy. Pump users should be under the supervision of a healthcare professional and should be instructed in using and troubleshooting the pump. Instruction should emphasize preventing IV related complications, including appropriate precautions to prevent accidental infusion of air.

The pump is suitable for intravenous (central line or peripheral access), arterial, subcutaneous, and epidural infusion.

The epidural route is recommended to provide anesthesia or administer analgesia for periods up to 96 hours.

Epidural administration of anesthetics is limited to the continuous mode only.

Epidural administration of analgesics may be delivered by continuous, bolus, or continuous/bolus.

For epidural use, the administration of drugs is restricted to those anesthetic and analgesic drugs approved for continuous epidural administration: Chlorprocaine Hydrochloride USP, Lidocaine Hydrochloride USP and Morphine Sulfate Injection USP, (Preservative Free).

WARNING: Delayed respiratory depression following continuous epidural administration of preservative-free morphine sulfate has been reported.

For epidural administration, the following is recommended:

- Nylon or Teflon[®] catheter
- Pump sets without Y-sites
- Epidural stickers for the pump indicating ongoing epidural administration

Epidural administration of drugs should be limited to medical professionals familiar with associated techniques and patient management problems. Proper epidural placement of the catheter is essential since catheter migration could result in intravascular or

intrathecal administration. Facilities practicing epidural administration must be equipped with resuscitative equipment, oxygen, naloxone, and other resuscitative drugs. Adequate monitoring equipment (e.g., Oximetry), is recommended for continuous monitoring of the patient during epidural administration. Patients must be observed for side effects frequently in a fully equipped and staffed environment for at least 24 hours following completion of drug administration by the epidural route.

The epidural space has 58 openings through which fluid can exit. Pressure build-up during administration is transient. However, if a large volume of fluid is administered over a short time period, the pressure takes longer to return to normal. If over-delivery occurs during administration, observe the patient closely for compression on the spinal cord (disorientation, headache, transient neuralgias) and drug overdose.

Contraindications for Use

The Abbott AIM Plus should not be used by patients who do not have the mental and physical capability or the emotional stability to receive infusion therapy with this pump.

Drugs not compatible with silicone rubber or PVC plastic, or not stable under infusion conditions should not be used with this system.

Clinician Specific Information

The pages listed below contain information specifically for use by clinicians in special situations. If the clinician feels this information should not be given to the patient, these pages should be removed:

Clinician Activated Loading Dose
Locking and Unlocking the Keypad

page 4-10
pages 8-11 and 8-12

Warnings and Cautions

The following is a list of warnings and cautions that should be heeded when operating the Abbott AIM Plus. Elsewhere in this manual, warnings and cautions that are relevant to the procedure being discussed are repeated. Pay attention to all alert messages.

General Cautions:

- Federal (USA) law restricts this device to sale by or on the order of a physician or other licensed practitioner.
- Manual references to specific values are approximate only unless indicated otherwise. Air-in-line sensitivity values are approximate only.
- Disconnect the pump from the patient before connecting the pump to a PC for downloading history.
- For those patients who are likely to be adversely affected by unintended operations and failures, including interrupted medication or fluid delivery from the device, close supervision and provision for immediate corrective action should be provided.

Regarding Drugs Used, Cartridge Sets, and Containers:

- Never use drugs that are incompatible with silicone rubber or PVC plastic.
- To reduce loss of potency for drugs known to be absorbed by plastic and silicone, begin infusion as soon as practical after priming the set. Use of high flow rates during infusion will minimize drug absorption.
- Do not use medications which are unstable under infusion conditions.
- Always use connections with luer lock fittings.
- Use aseptic technique with all fluid path connections. Remove the protective coverings as assembly progresses.
- Always close the slide clamps before removing the cartridge from the pump.

- Arrange tubing, cords, and cables to minimize the risk of patient strangulation or entanglement.
- Never use vented fluid containers (e.g., glass or rigid plastic) unless suspended from a pole and a Universal Adapter Pia, List No. 17015-48, is in place.
- Stop infusion if signs or symptoms of infiltration occur.

Regarding Air-in-Line and Infusion:

- To reduce the risk of infusing air, use an air-eliminating filter when the air-in-line alarm is off.
- Always remove all air from the cartridge, tubing and injection site. Always disconnect the set from the patient prior to priming.

Regarding Pump Operation:

- If the pump does not perform as stated in this manual, remove from service immediately.
- Always connect to grounded AC outlet when using the AC power supply.
- Do not use non-Abbott AC power supplies with the Abbott AIM Plus as this may result in damage to the pump's circuitry and microprocessor units.
- Installing batteries is recommended, regardless of the power source used, to provide continuing operation if AC power fails. Always **replace all four batteries** with new batteries when a change is required.
- Always avoid sources of high intensity electromagnetic radiation (e.g., radio transmitters, MRI scanners, microwave ovens, X-ray machines, and CAT scanners).
- Use of radio frequency emitting devices such as cellular telephones and 2-way radios in close proximity of this device may affect its operation.
- Possible explosion hazard exists if used in the presence of flammable anesthetics. Never use the pump in the presence of flammable or explosive vapors.

- Nonhazardous, low-level electrical potentials are commonly observed when fluids are administered using infusion devices. These potentials are well within accepted safety standards, but may create artifacts on voltage sensing equipment such as ECG, EMG and EEG machines. These artifacts vary at a rate that is associated with the infusion rate. If the monitoring machine is not operating correctly or has loose or defective connections to its sensing electrodes, these artifacts may be accentuated so as to simulate actual physiological signals. To determine if the abnormality in the monitoring equipment is caused by the infusion device instead of some other source in the environment, set the infusion device so that it is temporarily not delivering fluid. Disappearance of the abnormality indicates that it was probably caused by electronic noise generated by the infusion device. Proper setup and maintenance of the monitoring equipment should eliminate the artifact. Refer to the appropriate monitoring system documentation for setup and maintenance instructions.

Regarding Handling and Maintenance:

- Product damage may occur if proper care is not exercised during unpacking, installation, and use. Should the pump inadvertently be subjected to mishandling, check connections and programmed data to confirm no damage has occurred. Refer to *Section 13, Installation Test*, for further information.
- Always fully close the battery door when using batteries.
- Always avoid dropping or hitting the pump. If the pump is dropped or hit, always verify programmed data.
- Never use sharp objects (e.g., fingernails, pens, pencils or other probes) to program or clean the pump.
- To avoid mechanical or electronic damage, never submerge pump in water or other fluids and avoid fluid spills. If pump becomes wet, dry it immediately. Check connections and programmed data.
- Some cleaning and sanitizing compounds may slowly degrade components made from some plastic materials. Do not use compounds containing combinations of isopropyl alcohol and dimethyl benzyl ammonium chloride.

- Do not sterilize by heat, steam, ETO, or radiation. Apply disinfectants to the outside surface of the pump only. Do not use abrasive cleaners or materials on the pump. Using abrasive cleaners or cleaning solutions not recommended by Abbott Laboratories may result in product damage.
- Use only the AC power supply labeled for use with the Abbott AIM Plus to charge the battery pack.



Discount
CARDIOLOGY
www.discountcardiology.com

2

Basics

This section describes the basic procedures for using the Abbott AIM Plus. Five steps should be followed to begin a protocol.

1. Install the power source(s) and bolus cord (if required).
2. Set up the cartridge set and container.
3. Program the pump.
4. Prime the system.
5. Start the program.

Power Source(s) and Bolus Cord Setup

Install batteries, the battery pack, or the AC power supply before using the Abbott AIM Plus. If remote PCA bolus delivery is desired, connect the bolus cord.

Installing Disposable Batteries

To install batteries, complete the following steps:

- Switch the ON/OFF switch to OFF and remove the battery door on the bottom of the pump.
- Insert four AA alkaline batteries into the compartment; be sure the positive and negative battery terminals are placed according to the diagram in the battery compartment.
- Replace the battery door.

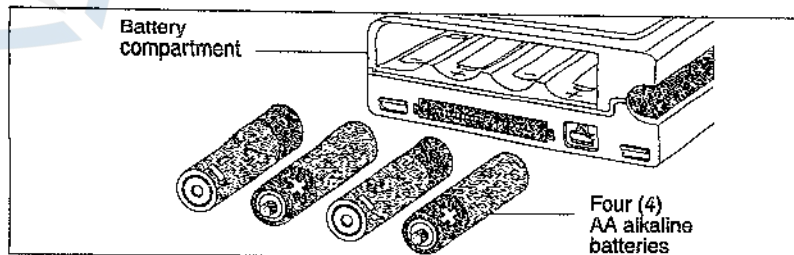

CAUTION: To assure proper pump operation, always replace all batteries with four fresh AA alkaline batteries when a change is required.

Note: Use of rechargeable AA batteries is not recommended.

Installing batteries is recommended regardless of the power source used to provide continuing operation if AC power fails.

Always fully close the battery door when using batteries.

Installing the Battery Pack

To install the battery pack, complete the following steps:

- Remove the battery compartment cover and store it in the slot on the battery pack so it can be easily retrieved.
- Remove the disposable batteries, if installed.
- Slide the battery pack into the battery compartment and snap into place.

To remove the pack, press the release tab and slide the pack out of the pump.

For charging instructions, go to page 10-1, *Battery Pack Recharging*.

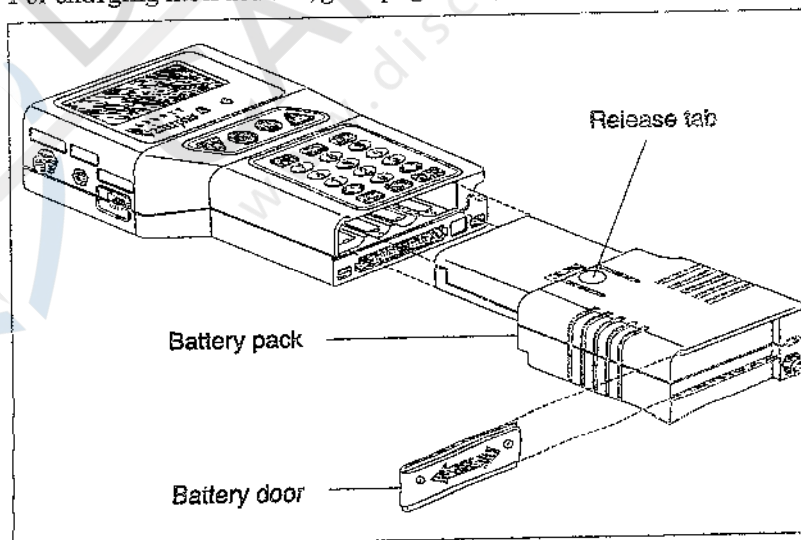

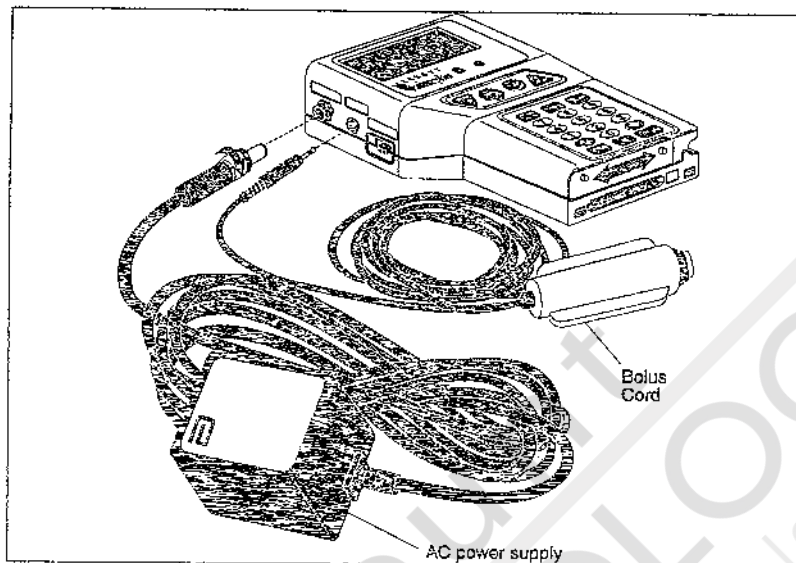

Connecting the AC Power Supply

To connect the AC power supply, complete the following steps:

- Insert the pin connector into the port on the pump.
- Turn the locking connector clockwise to secure.
- Plug the AC power supply into a standard wall outlet (grounded 110 volt).

CAUTION: Always connect to grounded AC outlet when using the AC power supply. Do not use AC power supplies not recommended by Abbott with the Abbott AIM Plus as this may result in damage to the pump's circuitry and microprocessor units.

Connecting the Bolus Cord

To connect the bolus cord, complete the following steps:

- Insert the pin connector into the port on the pump.
- Turn the locking connector clockwise to secure.

Cartridge Set and Container Setup

Before programming the pump, prepare the cartridge set and container for delivery, gravity prime the set, attach the anti-siphon valve extension set (if required), and load the cartridge in the pump.

CAUTION: To prevent contamination, use aseptic technique with all fluid path connections. Remove protective coverings as assembly progresses.

Preparing the Cartridge Set and Container

Open the delivery set package and remove the contents.

If using a cartridge set with an anti-siphon valve extension, separate the cartridge set and extension set and return the extension set to the package.

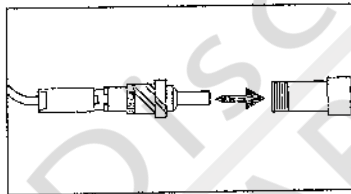

- Loosen, but do not remove, the protective cover from the distal male adapter.

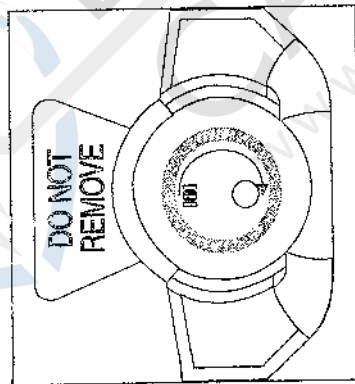

- The cartridge is packaged in the open position.

Leave the fluid path in the open position by turning the cartridge rotor until the dot is inside the parallel lines.

The cartridge must be open to allow fluid to flow through the tubing.

Gravity Priming the Set

The set should be gravity primed before loading into the pump to eliminate air from the tubing.

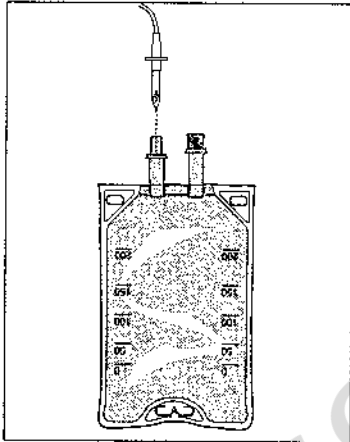

- Remove the protective covers from the fluid container administration port and the cartridge set piercing pin.

Turn the flexible fluid container so port is toward the ceiling and insert the piercing pin.

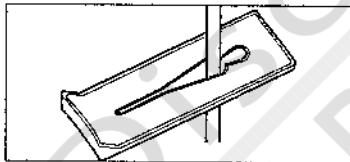

- Confirm that the slide clamp is open and allows fluid to flow through the tubing.

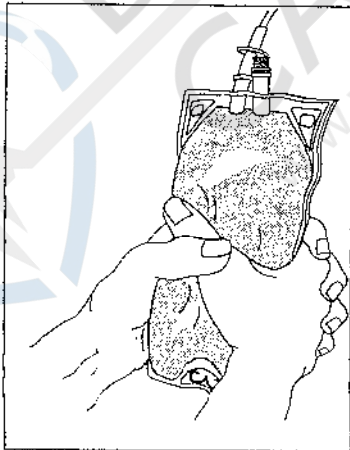

- Roll or squeeze the end of the fluid container to force fluid through the tubing and out of the distal (patient) end of the cartridge set.

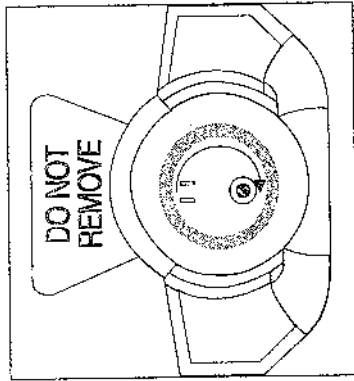

- Turn the control knob on the cartridge to the closed position (dot is inside of the red circle).

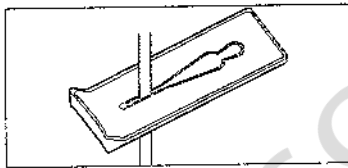

- Close the slide clamp.

Attaching the Anti-Siphon Valve Extension Set

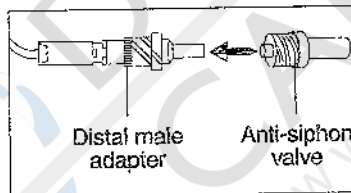

- Remove anti-siphon valve extension set from packaging.

Remove protective covers from the male connector on the cartridge set and the anti-siphon valve extension set, then aseptically connect two sets.

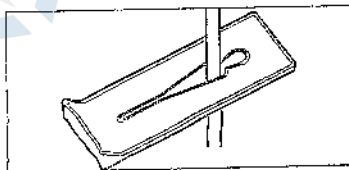

- Open slide clamp on anti-siphon valve extension set.

Loading the Cartridge

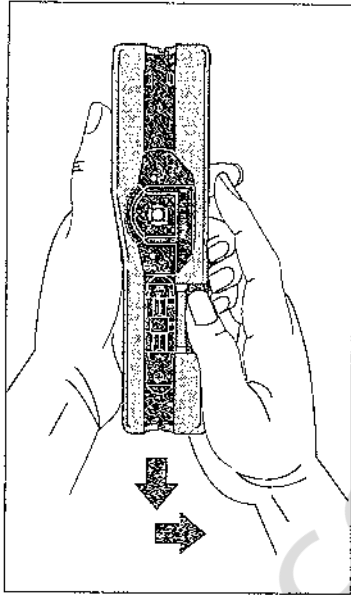

- Open the pump latch by sliding the latch down, then out.

Confirm the cartridge is closed (dot is inside the red circle).

Align the cartridge to fit the shape of the cartridge channel. The tab labeled DO NOT REMOVE should be to the left and the rotor should be positioned over the motor shaft.

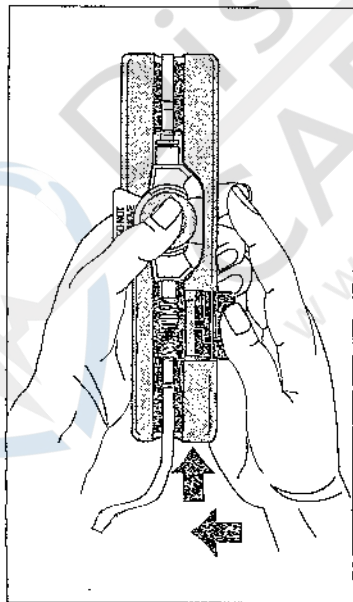

- Push cartridge into cartridge channel until firmly seated.

Close the pump latch by sliding the latch down, in and up.

Confirm that the cartridge is locked into place.

Powering On the Pump

When the ON/OFF switch is moved to the ON position, the pump automatically begins a self-test.

Troubleshooting: If display screen is blank, check for installed batteries and secure battery door. Check that the AC power supply connection is secure.

UNIT SELF-TEST
 IN PROGRESS
 TIME IS 10:00 AM
 SAT, JAN 1, 94

No action is required during the self-test.

If you are using both battery and AC power, the pump will advance to a programming display.

- To enter a new program go to the next section, *Entering a New Program*.
- To resume a program in progress, refer to page 2-1 for information about the Review/Resume function.
- To repeat the current program saved in the pump's memory, refer to page 8-2 for information about the New Container function.

If you are using only one source of power, or if the batteries are low, one of the three following alert screens will appear:

Confirm battery power only (as required)

USING BATTERIES

ENTER TO CONFIRM

Press [YES/ENTER] if using only the battery pack or batteries.

Troubleshooting: If using AC power, power off the pump and check that the outlet and pump connections are secure and that the outlet has power. Be sure to use only Abbott List 13586 AC Power Supply. Power on the pump again.

Confirm AC power only (as required)

NO BATTERY POWER
ENTER TO CONFIRM

Press [YES/ENTER] if using only AC power.

Troubleshooting: If the battery pack or batteries are installed, power off the pump and replace the battery pack with a fully-charged pack or replace all four batteries. Power on the pump again.

Confirm low batteries (as required)

LOW BATTERIES
ENTER TO CONFIRM

This display appears if battery power is low, whether or not the AC power supply is connected. Press [YES/ENTER].

Power off the pump and replace all four batteries or replace the battery pack with a fully-charged pack. Power on the pump again.

Entering a New Program

After the self-test completes, the screen you will see depends on if a program is saved in the pump's memory and if a lock level is active.

- If the memory is clear the Therapy Menu appears; go to *Choosing a Therapy* on the next page for further instructions.
- If a therapy is saved in the pump's memory, a description of the therapy appears on the display. You must clear the old program before beginning a new one. Go to *Clearing the Previous Therapy* on the next page for further instructions.
- If the pump is locked you cannot enter a new program without unlocking the pump. If a lock level is active the Change Menu appears after the self-test.

1 REVIEW/RESUME
2 NEW CONTAINER
3 NEW PROGRAM
4 CHANGE PROGRAM

To unlock the keypad press [OPTIONS] then enter the lock sequence number. For more information on the keypad lock function, refer to page 8-10.

Clearing the Previous Therapy

CURRENT THERAPY:
TPN WITH TAPER
USE CURRENT?
YES OR NO

Press [NO] to clear the program.

CLEAR
THE HISTORY?
YES OR NO

Press [YES/ENTER] to clear the Event History Log or press [NO] to continue writing to the current log.

If [YES/ENTER] is pressed, CLEARING HISTORY displays briefly. In either case, CLEARING PROGRAM displays briefly, then the Therapy Menu appears; go to *Choosing a Therapy* for further instructions.

Choosing a Therapy

When the pump is ready for programming, the Therapy Menu appears.

1 TPN
2 PAIN MANAGEMNT
3 INTERMITTENT
USE ↓ FOR MORE

Press the number for the therapy to be programmed. Use the arrow keys to scroll up and down the list.

Tip: When a menu is open, the numbered line does not have to be on the screen to be chosen.

Go to the section listed below for programming instructions specific to the therapy chosen.

- Press [1] for TPN and go to Section 3.
- Press [2] for Pain Management and go to Section 4.
- Press [3] for Intermittent and go to Section 5.
- Press [4] for Variable Time and go to Section 6.
- Press [5] for Continuous and go to Section 7.

Priming the System

After program review, but before pressing [START] to begin the protocol, prime the system using the pump's [PRIME] key.

WARNING: Remove air from the tubing before connecting the set to the patient. Arrange tubing, cords, and cables to minimize the risk of patient strangulation or entanglement.

xxxx.xmL INFUSED
PRESS START
TO INFUSE

With the pump in the stop mode and the cartridge loaded, press [PRIME].

PRIME THE SET?

YES OR NO

Press [YES/ENTER] to proceed with priming or press [NO] to return the pump to the stop mode.

DISCONNECT
THE LINE FROM
THE PATIENT NOW

No response required. This message remains on the screen for several seconds.

TO PRIME,
PRESS AND HOLD
THE 'PRIME' KEY

Press and hold [PRIME].

Note: The Prime Overuse alarm will activate if [PRIME] is held for two minutes. Press [SILENCE] once to clear the alarm.

PRIMING
x.x xx

Continue to hold [PRIME].

The prime volume accrues on the display.

PRIME COMPLETE?

YES OR NO

When [PRIME] is released this display appears. To continue priming, press [NO]. If priming is finished, press [YES/ENTER] to return the pump to the stop mode.

Programming Steps

Step 1: Select TPN delivery type

1 TPN CONTINUOUS
2 AND TAPER DOWN
3 AND TAPER UP
4 BOTH UP & DOWN

Press [1], [2], [3], or [4] to select appropriate TPN delivery.

Step 2: Program total TPN volume

TPN VOLUME TO BE INFUSED
0 mL
ENTER WHEN DONE

Use the numeric keys to enter the TPN volume.

If programming TPN Continuous, skip to Step 4.

Step 3: Set taper times

Set taper up and down times as applicable.

Note: For one hour enter 100, not 60.

Step 3A: Set taper up

TAPER UP TIME
00:00 HRS:MIN
ENTER WHEN DONE

Use the numeric keys to enter the time for the taper up to run.

Step 3B: Set taper down

TAPER DOWN TIME
00:00 HRS:MIN
ENTER WHEN DONE

Use the numeric keys to enter the time for the taper down to run.

Step 4: Set total time to infuse

TOTAL INFUSION
TIME
00:00 HRS:MIN
ENTER WHEN DONE

Use the numeric keys to enter the total TPN infusion time.

Step 5: Program KVO (keep vein open)

DO YOU WANT KVO
AFTER INFUSION?

YES OR NO

Press [YES/ENTER] if KVO is desired after TPN is complete.

If [NO] is pressed, skip to Step 6.

SET KVO RATE

0.0 mL/hr
ENTER WHEN DONE

Use the numeric keys to enter the KVO rate.

SET KVO TIME

00:00 HRS:MIN
ENTER WHEN DONE

Use the numeric keys to enter the length of time to deliver the KVO (for example, press [2] [0] for 20 minutes of KVO after TPN delivery).

Step 6: Program container size

The pump automatically calculates the container size required for TPN therapy plus KVO amount.

Volume that is used by priming the pump with the [PRIME] key is subtracted from the container but is not added to the amount infused.

KVO AT x.x mL/hr
CONTAINER SIZE
IS x mL
ENTER WHEN DONE

Press [YES/ENTER] to accept calculation, or use the numeric keys to change the value.

TPN Auto Tapering Down

Auto tapering down is only available if a taper down time was entered during programming.

Auto tapering down is activated when the continuous delivery portion of a TPN with Taper Down protocol is stopped.

The auto taper down feature is not available while the pump is in an alarm condition.

To begin auto tapering down, press [STOP] during TPN delivery. The following display appears:

DO YOU WANT
AUTO TAPERING?

YES OR NO

If no auto tapering is desired, press [NO] to return to the stop mode. Press [START] to resume therapy, if desired.

Press [YES/ENTER] to access auto tapering feature.

AUTO TAPERING
DOWN TIME
0:00 HRS:MIN
ENTER WHEN DONE

Use the numeric keys to enter the auto tapering down time.

The maximum auto taper time is three hours or two times the remaining volume divided by the continuous delivery rate, whichever is less.

DO YOU WANT TO
START TAPERING?

YES OR NO

Press [YES/ENTER] to resume delivery and begin tapering down.

Press [NO] to cancel auto tapering and return to the stop mode.

4







Pain Management

This section contains programming and operating instructions for pain management therapy only. Refer to *Section 2, Basics*, for setup, power-on, and priming instructions. Additional operating functions can be found in *Section 8, Change and Options Menus*.

Programming Tips

Many programming steps advance automatically when the screen is answered. For screens where a value is requested, use the numeric keys to input the value, then press the [YES/ENTER] key to advance to the next screen.

Here are some programming tips:

- Press  for explanation of the current screen and, if applicable, maximum and minimum values that can be programmed.
Press  to exit HELP.
- Press  to place a decimal point in a numeric value.
- Press  before pressing  to return the current value being entered to zero.
- Press  to return to a previously entered screen and change that entry if desired. Entries can be changed until the Program Review is complete; changing some parameters may require new entries for later screens.

Programming Steps

Step 1: Choose administration route and delivery type

1 INTRAVENOUS
2 EPIDURAL
3 SUBCUTANEOUS

Press number [1], [2], or [3] to select the route of administration.

1 CONTINUOUS
2 BOLUS ONLY
3 CONT. + BOLUS

Press [1], [2], or [3] to select type of delivery.

Tip: If you program a Continuous + Bolus therapy you will be able to change the continuous delivery rate or bolus amount to zero without reprogramming the pump. Refer to page 8-5 for more information about the Change Program function.

Step 2: Choose unit of delivery and concentration

1 SELECT mg/mL
2 SELECT µg/mL
3 SELECT mL

Press [1], [2], or [3] to select unit of delivery.

If mL is selected, go to Step 3.

The unit of delivery selected (mL, mg, or µg) carries through the remaining steps automatically. The examples in this manual show *x* for variable characters.

CONCENTRATION
0.0 xg/mL
ENTER WHEN DONE

Use the numeric keys to enter the concentration of mg/mL or µg/mL.

If programming Bolus Only, skip to Step 4.

Step 3: Set continuous delivery rate

SET RATE
0.0 xx/hr
ENTER WHEN DONE

Use the numeric keys to enter the rate in mL/hr, mg/hr, or µg/hr.

PROGRAM A
LOADING DOSE?

YES OR NO

Step 4: Program loading dose, if desired

Press [YES/ENTER] or [NO] to indicate if a loading dose is desired.

If programming Bolus Only or Cont. + Bolus and [NO] is pressed, go to Step 5.

If programming Continuous and [NO] is pressed, skip to Step 6.

SET LOADING DOSE

0.0 xx
ENTER WHEN DONE

Use the numeric keys to enter the loading dose in mL, mg, or μ g.

DELIVER THE
LOADING DOSE
NOW?
YES OR NO

Press [YES/ENTER] to begin loading dose immediately. Press [NO] to hold the loading dose for delivery at start of infusion.

If programming Continuous, skip to Step 6.

Step 5: Program bolus dose

SET BOLUS DOSE

0.0 xx
ENTER WHEN DONE

Use the numeric keys to set the bolus dose amount (mL, mg, or μ g).

BOLUS LOCKOUT

0 MINUTES
ENTER WHEN DONE

Use the numeric keys to set the bolus lockout time.

DOSE LIMIT
1 4 HOUR LIMIT
2 # BOLUSES/HOUR
3 NO DOSE LIMIT

Press [1] to set the four hour limit; go to Step 5A.

Press [2] to set a limit on the number of boluses per hour; go to Step 5B.

Press [3] if no dose limit is desired; go to Step 6.

Step 5A: 4 Hour Limit programming only

A 4 Hour Limit is the maximum volume (continuous plus bolus or bolus only amount in mL, mg, or μg) that may be delivered over a four-hour period. When the limit programmed is reached the continuous delivery will stop and a bolus will not be allowed. As the oldest delivery amounts age out of the 4 Hour Limit record, the pump accepts bolus requests or resumes continuous delivery (if programmed).

Note: A bolus in progress will not be stopped until the individual bolus volume has been delivered, therefore, a bolus delivery initiated before the programmed limit has been reached may exceed the limit at the completion of the bolus.

Note: Loading doses are not included in the 4 Hour Limit volume and a limit in effect does not prevent a delivery of a loading dose.

SET 4 HOUR LIMIT
0.0 xx
ENTER WHEN DONE

Use the numeric keys to enter the maximum volume for four hours.

Step 5B: # Boluses/Hour programming only

OF BOLUSES ALLOWED PER HOUR
0
ENTER WHEN DONE

Use the numeric keys to enter the maximum number of boluses to be allowed within an hour.

Step 6: Program container size

CONTAINER SIZE
0 xg
IN 0.0 mL
ENTER WHEN DONE

Use the numeric keys to enter a container size for mL, mg, or μg (second line is blank if programming in mL). Press [YES/ENTER] to accept.

If programming in mg or μg , but entering total mL is desired, press [\downarrow] to move to the mL line and enter the mL size. The calculated mg or μg container size is automatically displayed when a mL value is entered.

Volume that is used by priming the pump with the [PRIME] key is subtracted from the container but is not added to the amount infused.

Step 7: Select air sensitivity

AIR SENSITIVITY
1 HIGH
2 LOW
3 AIR ALARM OFF

Press [1] to select high air alarm sensitivity. The pump will alarm at approximately 100 μL of air. Go to Step 8.

Press [2] to select low air alarm sensitivity. The pump will alarm at approximately 300 μL of air. Go to Step 8.

Press [3] to turn the air alarm off. When [3] is selected, the following display appears:

USING AN AIR
ELIMINATING
FILTER?
YES OR NO

Press [YES/ENTER] if you are using an air-eliminating filter. The air-in-line detection will be turned off and air in the line will not be detected.

Press [NO] if you are not using a filter. The pump will alarm when more than 2.0 mL of air is detected.

Step 8: Review the program

Use the arrow keys to review the program. To change any entry, press [BACK-UP] until the desired programming screen is displayed.

When review is complete, press [YES/ENTER] to place the pump in the stop mode. For priming instructions, refer to page 2-11.

Stop Mode

Completing the program review or pressing [STOP] while in the run mode places the pump in the stop mode.

For mL, the amount infused and rate are shown (no rate is shown for Bolus Only programming). For mg or μg , the amount infused and volume infused in mL are shown.

```

xxxxx.x mL INFUSED
RATE  xxx.x mL/hr
PRESS START
TO INFUSE
  
```

OR

```

xxxxx.xxg INFUSED
OR    XXXX.XmL
PRESS START
TO INFUSE
  
```

Run Mode

Pressing [START] places the pump in the run mode.

For mL, the amount infused and rate are shown (no rate is shown for Bolus Only programming). For mg or μg , the amount infused, the volume infused in mL, and the rate are shown.

The amount infused (and for mg and μg the volume infused) accrues as the delivery progresses.

```

xxxxx.xmL INFUSED
RATE  xxx.x mL/hr
  
```

OR

```

xxxxx.xxg INFUSED
OR    XXXX.XmL
RATE  xxx.xg/hr
  
```

Bolus Dose Delivery

Bolus doses and delivery limits are set during programming. A bolus cord is available for patient bolus requests (go to page 2-3, *Connecting the Bolus Cord*, for setup instructions).

Starting a Bolus Dose Delivery

To start a bolus dose delivery, press either the [BOLUS] button on the top of the pump or the button on the end of the bolus cord.

One of the following displays appears, depending on the unit and type of delivery programmed:

```
xxxx.xmL INFUSED
RATE      x.xmL/hr
BOLUS DELIVERY
```

OR

```
xxxx xg INFUSED
OR      xxxxx.xmL
BOLUS DELIVERY
```

The pump sounds three beeps and the bolus delivery begins.

The amount infused accrues as the delivery progresses. The bolus dose delivery rate of 125 mL/hr is shown on the screen.

If the bolus delivery does not start, it may be locked out by one of the following conditions:

- bolus lockout period
- loading dose delivery in progress
- bolus dose delivery in progress
- per-hour bolus limit
- four-hour amount limit

After a bolus is delivered, the bolus amount is added to the total bolus amount in the Event History Log and the bolus delivered count is incremented. When a bolus is requested, whether the bolus is delivered or not, the bolus demand count is incremented.

Stopping a Bolus Dose Delivery

Press the [STOP] key to interrupt a bolus dose delivery.

When [START] is pressed again, the pump displays the following message:

COMPLETE BOLUS NOW? YES OR NO

Press [YES/ENTER] to deliver the remaining bolus amount. The bolus lockout time is set when the delivery completes.

Press [NO] to clear the undelivered bolus amount. The bolus lockout time is set from when the bolus dose was interrupted.

Completing a Bolus Dose Delivery after an Empty Container Alarm

If a bolus is in progress when an Empty Container alarm occurs, the amount of the undelivered bolus is saved in the pump's memory.

If you replace the empty container and use the New Container function to repeat the program, the pump displays the following message when [START] is pressed:

COMPLETE BOLUS NOW? YES OR NO

Press [YES/ENTER] to deliver the remaining bolus amount. The bolus lockout time is set when the delivery completes.

Press [NO] to clear the undelivered bolus amount. The bolus lockout time is set from when the Empty Container alarm interrupted the bolus dose.

Loading Dose Delivery

A loading dose amount can be set during programming.

A loading dose can be delivered during programming or delayed until after programming and priming are complete.

If the delivery is delayed until after programming, the pump displays the following message automatically when [START] is pressed:

DELIVER THE
LOADING DOSE
NOW?
YES OR NO

Press [YES/ENTER] to begin delivery.

The amount infused accrues as the delivery progresses.

When the loading dose is complete, the following occur:

- Programmed infusion begins automatically.
- Dose amount is logged to the history.
- Bolus lockout time is set (if applicable) and subsequent bolus requests are ignored until the lockout time has elapsed.

Note: When a program is reset using the New Container function, you are not asked again to deliver a loading dose.

If the loading dose is interrupted by pressing [STOP] the pump displays the following message when [START] is pressed again:

COMPLETE THE
LOADING DOSE?
YES OR NO

Press [YES/ENTER] to complete loading dose delivery. Press [NO] to discontinue the loading dose delivery.

Clinician Activated Loading Dose

Note: The Clinician Activated Loading Dose feature allows a healthcare provider to program and immediately deliver a loading dose at any time during a patient's therapy.

Clinician: If desired, remove this page to assure the patient does not have access to this feature.

This feature is available only when the pump is unlocked or in Therapy Lock.

To activate a loading dose delivery, press [STOP] to place the pump in the stop mode.

Press [YES/ENTER] immediately followed by the [0] key.

PROGRAM A
LOADING DOSE?

YES OR NO

Press [YES/ENTER] to program a loading dose. Press [NO] to return to the stop mode.

SET LOADING DOSE

x . x xx
ENTER WHEN DONE

Use the numeric keys to enter the loading dose in mL, mg, or μg .

DELIVER THE
LOADING DOSE
NOW?
YES OR NO

Press [YES/ENTER] to begin loading dose immediately.

After loading dose is complete, press [START] to restart infusion.

5







Intermittent

This section contains programming and operating instructions for intermittent therapy only. Refer to *Section 2, Basics*, for setup, power-on, and priming instructions. Additional operating functions can be found in *Section 8, Change and Options Menus*.

Programming Tips

Many programming steps advance automatically when the screen is answered. For screens where a value is requested, use the numeric keys to input the value, then press the [YES/ENTER] key to advance to the next screen.

Here are some programming tips:

- Press  for explanation of the current screen and, if applicable, maximum and minimum values that can be programmed.
Press  to exit HELP.
- Press  to place a decimal point in a numeric value.
- Press  before pressing  to return the current value being entered to zero.
- Press  to return to a previously entered screen and change that entry if desired. Entries can be changed until the Program Review is complete; changing some parameters may require new entries for later screens.

Programming Steps

Step 1: Choose unit of delivery and concentration

```
1 SELECT mg/mL
2 SELECT µg/mL
3 SELECT mL
```

Press [1], [2], or [3] to select unit of delivery.

If selecting mL, go to Step 2.

The unit of delivery selected (mL, mg, or µg) carries through the remaining steps automatically. The examples in this manual show *x* for variable characters.

```
CONCENTRATION
      0.0 xg/mL
ENTER WHEN DONE
```

Use the numeric keys to enter the concentration of mg/mL or µg/mL.

Step 2: Set dose amount

```
SET DOSE AMOUNT
      0.0 xx
ENTER WHEN DONE
```

Use the numeric keys to enter the amount for each dose in mL, mg, or µg.

Step 3: Set length of each dose delivery

```
INFUSION TIME
PER DOSE
      0:00 HRS:MIN
ENTER WHEN DONE
```

Use the numeric keys to set the length of time each dose is to infuse (for example, press [2] [0] if each dose is to deliver for 20 minutes).

Step 4: Set dose frequency

```
INFUSE DOSE
EVERY
      0:00 HRS:MIN
ENTER WHEN DONE
```

Use the numeric keys to set the dose frequency (for example, press [2] [0] [0] to start a dose every two hours).

Step 5: Program total number of doses

To determine the number of doses in the container, divide the size of the container by the dose amount.

NUMBER OF DOSES
IN CONTAINER
0
ENTER WHEN DONE

Use the numeric keys to set the number of doses in the container.

Step 6: Program KVO, if desired

KVO (Keep Vein Open) runs prior to a delayed start time, between doses, and after the last dose until the total container is infused.

DO YOU WANT KVO?

YES OR NO

Press [YES/ENTER] if KVO is desired, or press [NO] and go to Step 7.

SET KVO RATE

0.0 xx/hr
ENTER WHEN DONE

Use the numeric keys to enter the KVO rate at mL/hr, mg/hr, or µg/hr.

The following screen gives you the option of adding additional KVO time if needed.

ENTER KVO TIME
AFTER LAST DOSE
0:00 HRS:MIN
ENTER WHEN DONE

Use the numeric keys to enter the time to deliver KVO after the last dose (for example, press [1] [0] to deliver 10 minutes of KVO after the last dose).

Note: The end of the last dose is considered to be the end of the off cycle after the last dose is delivered.

Step 7: Set call back alarm, if desired

The call back alarm allows the pump to be placed in the stop mode and disconnected from the patient between doses.

At the set time before each dose (e.g., 10 minutes), the pump will begin beeping, START will flash on the display, and the alarm LED will flash to alert the patient or caregiver to reconnect the pump to the patient. Press [SILENCE] to mute the beeping for three minutes.

Note: The call back alarm works only when the pump is turned on and in the stop mode, so do not turn the pump off when disconnecting.

```

SET CALL BACK
ALARM FOR NEXT
DOSE?
YES OR NO
  
```

Press [YES/ENTER] to program a call back alarm just before the next dose.

If [NO] is pressed, go to Step 8.

```

SET CALL BACK
ALARM
0:00 HRS:MIN
ENTER WHEN DONE
  
```

Use the numeric keys to set the call back time (for example, press [1][0] to set the alarm to go off 10 minutes before the start of the dose delivery).

Step 8: Program container size

The minimum container size is calculated based on the number of doses plus KVO programmed. This does not include volume needed for priming the tubing or for KVO before a delayed start of first dose.

Volume that is used by priming the pump with the [PRIME] key is subtracted from the container but is not added to the amount infused.

CONTAINER SIZE
 x xg
IN x.x mL
ENTER WHEN DONE

Press [YES/ENTER] to accept.
(The second line is blank if programming in mL)

To increase the container size for priming and/or delayed first dose, use the numeric keys to enter a value for mL, mg, or μg . If programming in mg or μg but entering total mL is desired, press [\downarrow] to move to the mL line and enter the mL size. The calculated mg or μg container size is automatically displayed when a mL value is entered.

Step 9: Select air sensitivity

AIR SENSITIVITY
1 HIGH
2 LOW
3 AIR ALARM OFF

Press [1] to select high air alarm sensitivity. The pump will alarm at approximately 100 μL of air. Go to Step 10.

Press [2] to select low air alarm sensitivity. The pump will alarm at approximately 300 μL of air. Go to Step 10.

Press [3] to turn the air alarm off. When [3] is selected, the following display appears:

USING AN AIR
ELIMINATING
FILTER?
YES OR NO

Press [YES/ENTER] if you are using an air-eliminating filter. The air-in-line detection will be turned off and air in the line will not be detected.

Press [NO] if you are not using a filter. The pump will alarm when more than 2.0 mL of air is detected.

Step 10: Confirm correct time and select start time

```
CURRENT TIME IS
hh:mm XM
* KEY TO CHANGE
ENTER WHEN DONE
```

If time is correct, press [YES/ENTER]. To change time, press [OPTIONS], then follow the instructions on the display.

```
CURRENT TIME IS
hh:mm XM
START NOW?
YES OR NO
```

Press [YES/ENTER] to start delivery immediately after program review. Go to Step 11.

Press [NO] to program a specific start time.

Tip: If you would like to start delivery later but don't wish to specify a particular time now, press [YES/ENTER], complete the program review, then power off the pump. When the pump is powered on again delivery can be started immediately after program review.

```
SET START TIME
00:00 AM
ENTER WHEN DONE
```

Use the numeric keys to set a start time. Press [↵] to change to PM.

Note: Be sure the pump is powered on, the program review is completed, and [START] is pressed before the start time is reached or the protocol will be delayed up to 24 hours.

Step 11: Review the program

To change any entry, press [BACK-UP] until the desired programming screen is displayed.

When review is complete, press [YES/ENTER] to place the pump in the stop mode. For priming instructions, refer to page 2-11.

Stop Mode

Completing the program review or pressing [STOP] while in the run mode places the pump in the stop mode. The amount infused in mL, mg, or μg is shown.

```
xxxx.xxx INFUSED
NEXT DOSE hh:mmx
PRESS START
TO INFUSE
```

Dose status is shown on second line:
 GIVING DOSE x
 NEXT DOSE hh:mm x (A or P)
 ALL DOSES GIVEN
 NO START DELAY

Run Mode

Pressing [START] places the pump in the run mode. The amount infused in mL, mg, or μg accrues as delivery progresses.

```
xxxx.xxx INFUSED
GIVING DOSE x
```

Dose status is shown on second line:
 GIVING DOSE x
 NEXT DOSE hh:mm x (A or P)
 ALL DOSES GIVEN
 KVO x.x xx/hr

End of Infusion Alert

The End of Infusion alert message will flash on the bottom line of the display at the end of the off cycle for the last dose delivered.

If delivering KVO, the pump will beep five times when the condition occurs, then again every fifteen minutes thereafter; no user response is required.

If no KVO is programmed, the pump will beep continuously and the alarm LED will flash. Press [SILENCE] to mute alarm for two minutes, then [STOP] to place the pump in the stop mode.

Intermittent Delivery Interruptions

If a dose is started late, interrupted, or missed completely, the pump allows you to start delivery immediately or wait to begin delivery at the next scheduled dose start time.

A call-back alarm will sound in three minutes if an interruption message is not cleared. Until the message is cleared the dose delayed time will be updated if applicable.

If, while an interruption message is displayed, it becomes time for the next dose, the pump will begin dose delivery immediately.

Any skipped doses will be added onto the end of the program. Partially delivered doses will have the undelivered volume left in the container at the end of the program or delivered as KVO (if applicable).

Step 1: Respond to interruption screen

Follow the steps below as applicable to the screen displayed.

Step 1A: Confirm missed dose(s)

MISSED
nn DOSE(S).
ENTER TO CONFIRM

Press [YES/ENTER] to confirm doses missed.

The MISSED SCHEDULED START OF DOSE message appears; go to Step 1B.

Step 1B: Choose to begin missed start

MISSED SCHEDULED
START OF DOSE.
START DOSE NOW?
YES OR NO

Press [YES/ENTER] to start dose delivery or press [NO] to skip this dose.

Step 1C: Choose to continue interrupted dose

DOSE DELAYED FOR
nn MINUTE(S).
COMPLETE NOW?
YES OR NO

Press [YES/ENTER] to start dose delivery or press [NO] to discontinue this dose.

Step 2: Shift doses (if required)

DOSE OVERLAPS
NEXT SCHEDULED
DOSE BY
nn MINUTE(S).

This message displays for several seconds **only** if this dose will overlap with the start of the next. No response required.

NEXT DOSE STARTS
AT hh:mmxM SHIFT
REMAINING DOSES?
YES OR NO

This message displays whether or not there is an overlap.

Press [YES/ENTER] to shift the start times of the remaining doses. This maintains the programmed time between this dose and next dose.

Press [NO] to begin dose delivery without changing the next dose start time. The time between this dose and the next delivered dose is lengthened or shortened, as applicable. If there is an overlap, the skipped dose is added onto the end of the program.

Step 3: Confirm next dose start time

NEXT DOSE
START TIME
00:00 AM
ENTER TO CONFIRM

Press [YES/ENTER] to confirm start time of next dose delivery.

If the start time is not acceptable, change your response by pressing [BACK-UP] to go back a screen or to return to the stop mode. Reprogram the pump by pressing [CHANGE] then [3] to choose the New Program function.

Please pay careful attention to the notes below.

Variable time deliveries are based on a real time clock. You will have the opportunity to set the clock during programming.

- Changes are not allowed to variable time phases after [START] is pressed.
- Programming must be completed before the actual start time, otherwise the first phase (and subsequent phases) will not start until the programmed time is reached in the next 24 hour period (e.g., don't program a 9:00 a.m. start time for the first phase when the pump's time is currently 9:05 a.m.).
- Variable time speed protocols must be recalled and confirmed before the first phase start time.
- The best time to change batteries is during the base rate, KVO, or at times of no fluid delivery.
- Bolus doses take precedence over phase deliveries, phases take precedence over base rate delivery, and base rate takes precedence over KVO.

Programming Steps

Step 1: Choose phase type

PROGRAM PHASES
1 PERCENTAGES
2 RATES
3 DOSES

Press [1], [2], or [3] to select type of phase.

Step 2: Choose unit of delivery and concentration

1 SELECT mg/mL
2 SELECT µg/mL
3 SELECT mL

Press [1], [2], or [3] to select unit of delivery.

If mL is selected, go to Step 3.

The unit of delivery selected (mL, mg, or μg) carries through the remaining steps automatically. The examples in this manual show x for variable characters.

CONCENTRATION
0 $x\text{g/mL}$
ENTER WHEN DONE

Use the numeric keys to enter the concentration of mg/mL or $\mu\text{g/mL}$.

Step 3: Confirm correct time

CURRENT TIME IS
hh:mm xM
* KEY TO CHANGE
ENTER TO CONFIRM

If time is correct, press [YES/ENTER]. To change time, press [OPTIONS] and follow the instructions on the display.

Step 4: Program base rate, if desired

A base rate runs only when a phase is not running.

PROGRAM
A BASE RATE?
YES OR NO

To program a base rate, press [YES/ENTER].

If [NO] is pressed, go to Step 5.

SET BASE RATE
START TIME
00:00 AM
ENTER WHEN DONE

Use the numeric keys to set the base rate start time. Press [\updownarrow] to change to PM.

SET BASE RATE
STOP TIME
00:00 AM
ENTER WHEN DONE

Use the numeric keys to set the base rate stop time. Press [\updownarrow] to change to PM.

SET BASE RATE
0.0 xx/hr
ENTER WHEN DONE

Use the numeric keys to set the base rate of mL/hr , mg/hr , or $\mu\text{g/hr}$.

Step 5: Program phases

Go to the appropriate step to set the phase parameters.

Step 5A for Percentage programming.

Step 5B for Rate programming.

Step 5C for Dose programming.

Step 5A: Percentage programming

Note: The minimum delivery rate of the pump is 0.1 mL/hr. When programming a percentage of the total daily amount, if the percent desired will result in a rate of less than 0.1 mL/hr, the following message will display briefly: MINIMUM AMOUNT IS xx.x%.

SET DAILY AMOUNT
FOR ALL PHASES
0.0 xx
ENTER WHEN DONE

Use the numeric keys to set the total daily amount (in mL, mg, or µg) upon which to base the percentages.

SET PHASE 1
START TIME
00:00 AM
ENTER WHEN DONE

Use the numeric keys to set the phase start time. Press [↓] to change to PM.

SET PHASE 1
STOP TIME
00:00 AM
ENTER WHEN DONE

Use the numeric keys to set the phase stop time. Press [↓] to change to PM.

SET PHASE 1
PERCENTAGE
0.0 %
ENTER WHEN DONE

Use the numeric keys to set the percentage of the total daily (24-hour period) amount.

PROGRAM ANOTHER
PHASE?
YES OR NO

Press [YES/ENTER] to program another phase.

When 100% has been programmed the pump will automatically go to Step 6.

Step 5B: Rate programming

SET PHASE 1
START TIME
00:00 AM
ENTER WHEN DONE

Use the numeric keys to set the phase start time. Press [↕] to change to PM.

SET PHASE 1
STOP TIME
00:00 AM
ENTER WHEN DONE

Use the numeric keys to set the phase stop time. Press [↕] to change to PM.

SET PHASE 1
RATE
0.0 xx/hr
ENTER WHEN DONE

Use the numeric keys to set a rate of mL/hr, mg/hr, or µg/hr.

PROGRAM ANOTHER
PHASE?

YES OR NO

Press [YES/ENTER] to program up to 12 phases in 24 hours.

When all phases have been set, press [NO] and go to Step 6.

Step 5C: Dose programming

SET PHASE 1
START TIME
00:00 AM
ENTER WHEN DONE

Use the numeric keys to set the phase start time. Press [↕] to change to PM.

SET PHASE 1
STOP TIME
00:00 AM
ENTER WHEN DONE

Use the numeric keys to set the phase stop time. Press [↕] to change to PM.

SET PHASE 1
DOSE
0.0 xx
ENTER WHEN DONE

Use the numeric keys to set the phase dose in mL, mg, or µg.

PROGRAM ANOTHER
PHASE?

YES OR NO

Press [YES/ENTER] to program up to 12 phases in 24 hours.

When all phases have been set, press [NO] and go to Step 6.

Step 6: Program bolus dose, if desired

PROGRAM
A BOLUS DOSE?
YES OR NO

Press [YES/ENTER] to program a bolus dose (bolus delivery rate is 400 mL/hr), or press [NO] and skip to Step 7.

SET BOLUS DOSE
0.0 xx
ENTER WHEN DONE

Use the numeric keys to set the bolus dose amount in mL, mg, or μ g.

BOLUS LOCKOUT
0 MINUTES
ENTER WHEN DONE

Use the numeric keys to set the bolus lockout time.

Step 7: Program KVO, if desired

DO YOU WANT KVO?
YES OR NO

KVO (Keep Vein Open) runs when no bolus, phase, or base rate delivery is in progress.

Press [YES/ENTER] if KVO is desired, or press [NO] and skip to Step 8.

SET KVO RATE
0.0 xx/hr
ENTER WHEN DONE

Use the numeric keys to set a KVO rate of mL/hr, mg/hr, or μ g/hr.

The pump will automatically calculate the KVO amount to be delivered between the phases, however, it does not calculate any KVO between the end of the last phase and the beginning of the first phase. If you want KVO for this period, program that time now. For example, if the last phase ends at 3:00 AM and the first phase starts at 3:00 AM, add 5 hours to the KVO time.

SET KVO TIME
AFTER LAST DOSE
0:00 HRS:MIN
ENTER WHEN DONE

Use the numeric keys to enter the time to deliver KVO after the last phase.

Step 8: Program container size

The minimum container size for a 24-hour cycle displays (second line is blank if programming in mL).

Note: Bolus requests, delayed start KVO, and priming volumes are not reflected in the minimum container size; the container size must be increased to compensate for these volumes.

If the program is to deliver for more than one day, multiply the 24-hour amount by the number of days to deliver.

Volume that is used by priming the pump with the [PRIME] key is subtracted from the container but is not added to the amount infused.

CONTAINER SIZE
x xg
IN x.x mL
ENTER WHEN DONE

Press [YES/ENTER] to accept.

To increase the container size, use the numeric keys to enter a value for mL, mg, or μ g. If programming in mg or μ g but entering total mL is desired, press [↵] to move to the mL line and enter the mL size. The calculated mg or μ g container size is automatically displayed when a mL value is entered.

Step 9: Select air sensitivity

AIR SENSITIVITY
1 HIGH
2 LOW
3 AIR ALARM OFF

Press [1] to select high air alarm sensitivity. The pump will alarm at approximately 100 μ L of air. Go to Step 10.

Press [2] to select low air alarm sensitivity. The pump will alarm at approximately 300 μ L of air. Go to Step 10.

Press [3] to turn the air alarm off. When [3] is selected, the following display appears:

USING AN AIR ELIMINATING FILTER? YES OR NO

Press [YES/ENTER] if you are using an air-eliminating filter. The air-in-line detection will be turned off and air in the line will not be detected.

Press [NO] if you are not using a filter. The pump will alarm when more than 2.0 mL of air is detected.

Step 10: Review the program

Use the arrow keys to review the program. To change any entry, press [BACK-UP] until the desired programming screen is displayed.

When review is complete, press [YES/ENTER] to place the pump in the stop mode. For priming instructions, refer to page 2-11.

Stop Mode

Completing the program review or pressing [STOP] while in the run mode places the pump in the stop mode. The amount infused in mL, mg, or μg is shown.

```
xxxx.x xx INFUSED
NEXT DOSE hh:mmxx
PRESS START
TO INFUSE
```

The dose status is shown in the second line:
GIVING DOSE x
NEXT DOSE hh:mm x (A or P)

Run Mode

Pressing [START] places the pump in the run mode. The amount infused in mL, mg, or μg accrues as delivery progresses.

```
xxxx.x xx INFUSED
GIVING DOSE x
```

The dose status is shown on the second line:
GIVING DOSE x
NEXT DOSE hh:mm x (A or P)

KVO delivery in progress is shown on the third line:
KVO x.x xx/hr

Bolus Dose Delivery

Bolus doses and delivery limits are set during programming. A bolus cord is available for patient bolus requests (refer to page 2-3, *Connecting the Bolus Cord*, for setup instructions).

Starting a Bolus Dose Delivery

To start a bolus dose delivery, press either the [BOLUS] button on the top of the pump or the button on the end of the bolus cord. The following display appears:

```

xxxx.x xx INFUSED
NEXT DOSE hh:mm x
BOLUS DELIVERY
```

The pump sounds three beeps and the bolus delivery begins. The dose status is shown on the second line.

The amount infused in mL, mg, or μg accrues as the delivery progresses. The approximate delivery rate of the bolus dose is 400 mL/hr. After a bolus is delivered, the bolus amount is added to the total bolus amount in the Event History Log and the bolus delivered count is incremented. When a bolus is requested, whether the bolus is delivered or not, the bolus demand count is incremented.

Note: If the bolus delivery does not start, it may be locked out by a bolus lockout period or a bolus dose delivery in progress.

Stopping a Bolus Dose Delivery

Press the [STOP] key to interrupt a bolus dose delivery. When [START] is pressed again, the pump displays the following message:

```

COMPLETE BOLUS
NOW?

YES OR NO
```

Press [YES/ENTER] to deliver the saved bolus amount. The bolus lockout time is set when the delivery completes.

Press [NO] to clear the undelivered bolus amount. The bolus lockout time is set from when the bolus was interrupted.

Completing a Bolus Dose Delivery after an Empty Container Alarm

If a bolus is in progress when an Empty Container alarm occurs, the amount of the undelivered bolus is saved in the pump's memory.

You may replace an empty container and repeat the program using the New Container function (refer to page 8-2 for instructions). This message will display when [START] is pressed:

COMPLETE BOLUS NOW? YES OR NO

Press [YES/ENTER] to deliver the saved bolus amount. The bolus lockout time is set when the delivery completes.

Press [NO] to clear the undelivered bolus amount. The bolus lockout time is set from when the Empty Container alarm interrupted the bolus dose delivery.

Variable Time Delivery Interruptions

If a phase is started late or interrupted, you may start delivery immediately or wait to begin delivery at the next scheduled phase start time. If you miss a phase completely you may begin delivery at any time during the next phase.

A call-back alarm will sound in three minutes if an interruption message is not cleared. Until the message is cleared the length of the delay will be updated if applicable. If while an interruption message is displayed it becomes time for the next phase, the pump will begin delivery immediately.

Undelivered volume from missed or partially delivered phases will be left in the container at the end of the 24 hour cycle or delivered as KVO (if applicable).

Note: Programming must be completed before the actual start time, otherwise the first phase (and subsequent phases) will not start until the programmed time is reached in the next 24 hour period (e.g., don't program a 9:00 a.m. start time for the first phase when the pump's time is currently 9:05 a.m.).

Step 1: Respond to interruption screen

Follow the steps below as applicable to the screen displayed.

Step 1A: Confirm missed phase(s)

```
MISSED
nn PHASE(S)
ENTER TO CONFIRM
```

Press [YES/ENTER] to confirm the number of phases missed.

If the next phase start time has passed, the MISSED SCHEDULED START OF PHASE message appears; go to Step 1B.

Step 1B: Choose to begin missed start

```
MISSED SCHEDULED
START OF PHASE.
START PHASE NOW?
YES OR NO
```

Press [YES/ENTER] to start phase or press [NO] to skip this phase.

Step 1C: Choose to continue interrupted phase

```
PHASE DELAYED
FOR nn MINUTE(S)
CONTINUE PHASE?
YES OR NO
```

Press [YES/ENTER] to continue phase or press [NO] to skip this phase.

Step 2: Confirm next phase start time

```
NEXT PHASE
START TIME
00:00 xM
ENTER TO CONFIRM
```

Press [YES/ENTER] to confirm start time of next phase.

If the start time is not acceptable, change your response by pressing [BACK-UP] to go back a screen or reprogram the pump by pressing [CHANGE] then [3] to choose the *New Program function*.

7







Continuous

This section contains programming and operating instructions for continuous therapy only. Refer to *Section 2, Basics*, for setup, power-on, and priming instructions. Additional operating functions can be found in *Section 8, Change and Options Menus*.

Programming Tips

Many programming steps advance automatically when the screen is answered. For screens where a value is requested, use the numeric keys to input the value, then press the [YES/ENTER] key to advance to the next screen.

Here are some programming tips:

- Press  for explanation of the current screen and, if applicable, maximum and minimum values that can be programmed.
Press  to exit HELP.
- Press  to place a decimal point in a numeric value.
- Press  before pressing  to return the current value being entered to zero.
- Press  to return to a previously entered screen and change that entry if desired. Entries can be changed until the Program Review is complete; changing some parameters may require new entries for later screens.

Programming Steps

Step 1: Choose unit of delivery and concentration

```
1 SELECT mg/mL
2 SELECT µg/mL
3 SELECT mL
```

Press [1], [2], or [3] to select unit of delivery.

If mL is selected, go to Step 2.

The unit of delivery selected (mL, mg, or µg) carries through the remaining steps automatically. The examples in this manual show *x* for variable characters.

```
CONCENTRATION
0.0 xg/mL
ENTER WHEN DONE
```

Use the numeric keys to enter a concentration of mg/mL or µg/mL.

Step 2: Set rate of delivery

```
SET RATE
0.0 xx/hr
ENTER WHEN DONE
```

Use the numeric keys to enter the rate of mL/hr, mg/hr, or µg/hr.

Step 3: Program container size

```
CONTAINER SIZE
      x xg
IN      x.x mL
ENTER WHEN DONE
```

Use the numeric keys to enter a value for mL, mg, or µg. (second line is blank if programming in mL).

Press [YES/ENTER] to accept.

If programming in mg or µg but entering total mL is desired, press [↓] to move to the mL line and enter the mL size. The *calculated mg or µg container size* is automatically displayed when a mL value is entered.

Volume that is used by priming the pump with the [PRIME] key is subtracted from the container but is not added to the amount infused.

Step 4: Select air sensitivity

AIR SENSITIVITY
1 HIGH
2 LOW
3 AIR ALARM OFF

Press [1] to select high air alarm sensitivity. The pump will alarm at approximately 100 μ L of air. Go to Step 5.

Press [2] to select low air alarm sensitivity. The pump will alarm at approximately 300 μ L of air. Go to Step 5.

Press [3] to turn the air alarm off. When [3] is selected, the following display appears:

USING AN AIR
ELIMINATING
FILTER?
YES OR NO

Press [YES/ENTER] if you are using an air-eliminating filter. The air-in-line detection will be turned off and air in the line will not be detected.

Press [NO] if you are not using a filter. The pump will alarm when more than 2.0 mL of air is detected.

Step 5: Review the program

Use the arrow keys to review the program. To change any entry, press [BACK-UP] until the desired programming screen is displayed.

When review is complete, press [YES/ENTER] to place the pump in the stop mode. For priming instructions, refer to page 2-11.

Stop Mode

Completing the program review or pressing [STOP] while in the run mode places the pump in the stop mode. For mL, the amount infused and rate are shown. For mg or μg , the amount infused and volume infused in mL are shown.

```

xxxxx.xmL INFUSED
RATE      x.xmL/hr
PRESS START
TO INFUSE
  
```

OR

```

xxxxxg    INFUSED
OR        x.x mL
PRESS START
TO INFUSE
  
```

Run Mode

Pressing [START] places the pump in the run mode. For mL, the amount infused and rate are shown. For mg or μg , the amount infused, the volume infused in mL, and the rate are shown. The amount infused (and for mg and μg , the volume infused) accrues as the delivery progresses.

```

x.xmL    INFUSED
RATE     x.xmL/hr
  
```

OR

```

xxg      INFUSED
OR       x.x mL
RATE     xxg/hr
  
```

www.arkdisco.com

8

Change and Options Menus

The Change Menu is used to revise the program after initial programming is complete.

The Options Menu is used to adjust a number of features to better fit the patient's needs.

The Change Menu

The Change Menu is available when [CHANGE] is pressed in the stop mode or run mode. In the run mode, only the Review/Resume function is available.

- 1 REVIEW/RESUME
- 2 NEW CONTAINER
- 3 NEW PROGRAM
- 4 CHANGE PROGRAM

To choose an item from the menu, press the corresponding number for that item.

Function 1: Review/Resume

If the pump has been powered off for more than five minutes you must use the Review/Resume function to resume delivery of the current program.

Slide the ON/OFF switch to the ON position to turn the pump on. Allow the self-test to complete.

If the pump is unlocked or in Therapy Lock the USE CURRENT? confirmation screen appears; press [YES/ENTER] to use the current program. If the pump is in Full, Rate Change, or New Container Lock the pump displays the current therapy name briefly (no response required), then the Change Menu appears automatically.

1	REVIEW/RESUME
2	NEW CONTAINER
3	NEW PROGRAM
4	CHANGE PROGRAM

Press [1].

Press [↓] to review the program, then [YES/ENTER] to go to the stop mode.

Press [START] to resume delivery.

Function 2: New Container

A program can be repeated at power on or from the stop mode.

This function not available when the pump is in Full Lock.
--

To repeat the program from the stop mode press [CHANGE] to access the Change Menu.

To repeat the program from power on, slide the ON/OFF switch to the ON position and allow the self-test to complete.

If the pump is unlocked or in Therapy Lock the USE CURRENT? confirmation screen appears; press [YES/ENTER] to use the current program. If the pump is in Rate Change or New Container Lock the pump displays the current therapy name briefly (no response required), then the Change Menu appears automatically.

1	REVIEW/RESUME
2	NEW CONTAINER
3	NEW PROGRAM
4	CHANGE PROGRAM

Press [2].

Note: If changing the container for a TPN, Intermittent, or Variable Time therapy see the following subsections for additional information.

NEW CONTAINER

This screen displays for several seconds; no response required. The amount infused and the run time parameters are cleared.

Press [3] to review the program, then [YES/ENTER] to go to the stop mode. No review is required if the pump has been powered off for less than five minutes.

Press [START] to begin delivery.

TPN Therapy Information

You can change the TPN volume, taper up and down times, and total TPN time of the current program immediately after selecting the New Container function.

Before pressing [START], press [CHANGE] then [4] to access the Change Program function; for instructions refer to page 8-5.

Intermittent Therapy Information

If you choose New Container while the protocol is between dose deliveries, or after all the doses have been delivered and before the END OF INFUSION alarm occurs, the pump maintains the programmed dose frequency.

If you choose New Container after all the doses have been delivered and the END OF INFUSION alarm has occurred, the first dose begins immediately when you press [START].

If you choose New Container during a dose delivery the following display appears:

DOSE DELIVERY IN
PROGRESS. CHANGE
DOSE START TIME?
YES TO CONTINUE.

Press [YES] to stop the current dose and reset the program. When you press [START] the first dose will begin delivery immediately.

If you want to keep the same time between doses, wait until the current dose is complete to reset the program. Press [BACK-UP] then [START] to continue the current dose.

Variable Time Therapy Information

When using the New Container function, you have the option of continuing delivery from the time of interruption or stopping delivery until the start of phase one, base rate, or KVO.

CONTINUE
CURRENT
PROTOCOL?
YES OR NO

Press [YES] to continue current protocol. The amount infused and prime volume are cleared. Delivery will continue from the point of interruption.

Press [NO] to reset the protocol and start over. The amount infused and prime volume are cleared. Delivery will begin at the next scheduled start time of phase one, base rate, or KVO.

Function 3: New Program

A new program can be entered at power on or from the stop mode.

This function not available with a Full, New Container, or Rate Change Lock. A Therapy Lock restricts this function to the current type of therapy.

Refer to page 2-9 for instructions on how to enter a new program from power on.

To enter a new program from the stop mode press [CHANGE] to access the Change Menu.

1 REVIEW/RESUME
2 NEW CONTAINER
3 NEW PROGRAM
4 CHANGE PROGRAM

Press [3].

CLEARING PROGRAM

This screen displays for several seconds; no response required.

1 TPN
2 PAIN MANAGEMENT
3 INTERMITTENT
USE ↓ FOR MORE

Press the number for the therapy to be programmed. Use the arrow keys to scroll up and down the list.

Tip: The numbered line does not have to be on the screen to be chosen.

- Press [1] for TPN and go to Section 3.
- Press [2] for Pain Management and go to Section 4.
- Press [3] for Intermittent and go to Section 5.
- Press [4] for Variable Time and go to Section 6.
- Press [5] for Continuous and go to Section 7.

Function 4: Change Program

Changes to the current program can be made at power on or from the stop mode.

Refer to the chart on the following page for change restrictions for each therapy type.

This function not available with a Full or New Container Lock.

With a Rate Change Lock the continuous delivery rate and bolus amount can be changed within ranges set.

To revise the program from the stop mode press [CHANGE] to access the Change Menu.

To revise the program from power on when the pump has been off for more than five minutes, slide the ON/OFF switch to the ON position to turn the pump on. Allow the self-test to complete. If the pump is unlocked or in Therapy Lock the USE CURRENT? confirmation screen appears. Press [YES/ENTER] to use the current program and go to the Change Menu. If the pump is in Rate Change Lock the pump displays the current therapy name briefly (no response required), then the Change Menu appears automatically.

- 1 REVIEW/RESUME
- 2 NEW CONTAINER
- 3 NEW PROGRAM
- 4 CHANGE PROGRAM

Press [4].

The current program displays for several seconds followed by the program values. Numeric values are displayed as they were originally entered.

Program values that cannot be changed will not be displayed. Use the number keys, decimal point, [YES/ENTER], and [NO] to change entries as required. After all changes are confirmed, press [↵] to review the program, then [YES/ENTER] to go to the stop mode.

Press [START] to begin delivery.

This chart shows which parameters for each type of therapy can be changed. Some changes are only available before [START] is pressed. If a parameter cannot be changed, use the New Program function to enter a new program.

Change Function Restrictions			
Therapy Type	Can be changed at any time	Can be changed before [START] is pressed	Cannot be changed
TPN	KVO rate & time Container size Air sensitivity	TPN volume Taper times Total TPN time	Therapy type
Pain Management	* Concentration Delivery rate Loading dose Bolus parameters Container size Air sensitivity		Therapy type Admin. route ** Delivery type Unit of delivery
Intermittent	* Concentration Dose parameters KVO rate & time Call back alarm Container size Air sensitivity	Start time	Therapy type Unit of delivery
Variable Time	* Concentration Base rate times Base rate Bolus parameters KVO rate & time Container size Air sensitivity	Phase parameters	Therapy type Unit of delivery
Continuous	Delivery rate Container size Air sensitivity		Therapy type Unit of delivery

* If the concentration is changed, all other program parameters are cleared and must be re-entered.

** While you cannot change the delivery type, if a Continuous + Bolus therapy is programmed you can change the continuous rate or bolus amount to zero. This function is not available with a New Container Lock or Full Lock and may be restricted by the minimum values chosen with a Rate Change Lock.

The Options Menu

The Options Menu is available when [OPTIONS] is pressed in the stop mode.

In the run mode, the options are restricted to the Review Program History, Keypad Lock, Print, and Alarm Log functions.

- | | |
|---|----------------|
| 1 | REVIEW PROGRAM |
| 2 | HISTORY |
| 3 | KEYPAD LOCK |
| 4 | AIR SENSOR |
| 5 | SET CLOCK |
| 6 | PRINT |
| 7 | SPEED PROTOCOL |
| 8 | ADJUSTMENTS |
| 9 | ALARM LOG |

Only three items display at a time; use the arrow keys to scroll up and down the list. To choose an item from the menu, press the corresponding number for that item.

Tip: The numbered item does not have to be on the screen to be chosen.

Function 1: Review Program

The program can be reviewed while in the run mode or stop mode. To review the program, press [OPTIONS], then [1] to choose the Review Program function.

The information listed is appropriate to the program entered. Use the arrow keys to scroll up and down the list of entries. Press [BACK-UP] to exit at any time. If 20 seconds elapse without either the up arrow or down arrow key being pressed, the pump returns to the mode from which the review was requested.

Function 2: History

The Abbott AIM Plus' Event History Log is a list of the following:

- Delivery information (up to the time the menu is opened)
- Program option (e.g., Pain Management with Intravenous)
- Container size
- Air alarm setting
- Up to 512 history events

The current program information does not display as part of the Event History Log; to review the program, follow the instructions in the previous section. The History Menu can be accessed from the run or stop mode, or in the first programming screen.

Alarm error codes 1-7 are displayed with a text description and other alarms are listed by error code; go to page 9-4, *Alarms*, for a description of each code.

□ Displaying the History

To display the history log, press the [OPTIONS] key, and press [2] to choose the History Menu.

```
1 SHOW HISTORY
2 PRINT HISTORY
3 CLEAR HISTORY
```

Press [1] to show the history log (the following is an example only).

```
TIME IS 12:00 AM
SUN JAN 1, 95
USE ↑↓ FOR MORE
```

Use the arrow keys to scroll up and down the log.

Press [BACK-UP] to exit at any time.

If 30 seconds elapse without an arrow key being pressed, the pump returns to the mode from which the review was requested.

□ Printing the History

Connect the pump to a printer or PC before starting the Print History function (for setup instructions refer to page 8-16, *Using a Printer*, or page 8-18, *Downloading to a PC*).

To print or download the history, press [OPTIONS] then [2] to access the History Menu.

```
1 SHOW HISTORY
2 PRINT HISTORY
3 CLEAR HISTORY
```

Press [2] to print or download the history.

After the function is complete, the pump returns to the mode it was in when [OPTIONS] was pressed.

❑ Clearing the History

The current program is not affected by clearing the history.

```
This function not available if any lock level is active.
```

To clear the history log, place the pump in the stop mode, press the [OPTIONS] key, and press the [2] key to choose the History Menu.

```
1 SHOW HISTORY
2 PRINT HISTORY
3 CLEAR HISTORY
```

Press [3] to clear the history.

```
CLEARING HISTORY
```

The pump clears the history and returns to the stop mode.

Function 3: Keypad Lock

Keypad lock can be used to restrict patient access to various pump operations. When the pump is locked a lock icon appears on both sides of the IN PROGRESS message during the power on self-test and at the lower right on the run mode display.

The following chart outlines which actions can be performed in each of the lock levels.

Operations Allowed	Unlocked	Therapy Lock	Rate Change	New Container	Full Lock
Starting and stopping an infusion	Yes	Yes	Yes	Yes	Yes
Turning the pump on and off	Yes	Yes	Yes	Yes	Yes
Delivering a bolus (if applicable)	Yes	Yes	Yes	Yes	Yes
Unlocking the keypad	Yes	Yes	Yes	Yes	Yes
Using [SILENCE] and [HELP] keys	Yes	Yes	Yes	Yes	Yes
Accessing display and print functions	Yes	Yes	Yes	Yes	Yes
Resetting the current program to hang a new container	Yes	Yes	Yes	Yes	No
Priming the pump	Yes	Yes	Yes	Yes	No
Changing the continuous or bolus delivery rates in a pain management protocol	Yes	Yes	Yes	No	No
Recalling and reviewing a speed protocol * With a therapy lock, speed protocols available only for current type of therapy	Yes	Yes*	No	Yes	No
Assigning and deleting speed protocols	Yes	Yes	No	No	No
Deliver a Clinician Activated Loading Dose	Yes	Yes	No	No	No
Clearing the program, or changing the parameters, within the same therapy	Yes	Yes	No	No	No
Changing the type of therapy	Yes	No	No	No	No

Clinician: If desired, remove this page to assure the patient does not have access to this feature.

□ Locking the Keypad

To lock the keypad from the run or stop mode, press the [OPTIONS] key to display the Options Menu then press the [3] key to access the Keypad Lock Menu. Complete the following steps.

Step 1: Select lock level

1	THERAPY LOCK
2	RATE CHANGE
3	NEW CONTAINER
4	FULL LOCK

Use the numeric keys to select the desired lock level.

For Therapy, New Container, and Full Lock Levels, go to Step 3.

Step 2: Set ranges for Rate Lock

Set the minimum and maximum programmable ranges for the continuous delivery rate and bolus dose in a Pain Management program.

SET	xxxxx	RANGE
MIN	0	xx/hr
MAX	0	xx/hr
ENTER WHEN DONE		

MIN will flash. Use the numeric keys to select the minimum range, then press [YES/ENTER] to accept. MAX will begin to flash. Repeat these steps for the maximum range.

Step 3: Enter lock sequence number

ENTER THE LOCK SEQUENCE NUMBER

Press [1] [3] [9] [6] [7].

As the numbers are entered, asterisks display on the screen.

Note: If KEYPAD UNLOCKED displays for several seconds before the pump returns to the stop mode, an incorrect number was entered; repeat the locking steps until the Lock Level screen appears.

LOCK LEVEL:
4 FULL LOCK

After the correct access code is entered, the lock level chosen displays for several seconds and three short beeps sound before the pump returns to the mode it was in when [OPTIONS] was pressed.

When the pump is started, a lock icon and the lock level number will appear in the lower right corner of the screen.

☐ Unlocking the Keypad

To unlock the keypad from the run or stop mode, press the [OPTIONS] key to display the Options Menu then press the [3] key to access the Keypad Lock Menu.

ENTER THE LOCK
SEQUENCE NUMBER

Press [1] [3] [9] [6] [7].

As the numbers are entered, asterisks display on the screen.

LOCK LEVEL:
KEYPAD UNLOCKED

After the correct access code is entered, KEYPAD UNLOCKED displays for several seconds and three short beeps sound before the pump returns to the mode it was in when [OPTIONS] was pressed.

Function 4: Air Sensor

The operator can adjust the air-in-line alarm sensitivity during programming or after infusion begins. Removing power or turning off the device has no effect on the air alarm setting for the current program or any of the speed protocols.

To adjust the setting during programming, wait for the air sensitivity screen to appear during the programming steps (refer to the appropriate therapy section for complete instructions).

To adjust the setting after programming is complete, place the pump in the stop mode, press the [OPTIONS] key to display the Options Menu, and press the [4] key to access the Air Sensor Menu.

```
AIR SENSITIVITY
1 HIGH
2 LOW
3 AIR ALARM OFF
```

Press [1], [2], or [3] to select the desired sensitivity setting.

If you select high sensitivity the pump will alarm at approximately 100 μ L of air.

If you select low sensitivity the pump will alarm at approximately 300 μ L of air.

If you turn the air alarm off there are two options. When [3] is selected, the following display appears:

```
USING AN AIR
ELIMINATING
FILTER?
YES OR NO
```

Press [YES/ENTER] if you are using an air-eliminating filter. The air-in-line detection will be turned off and air in the line will not be detected.

Press [NO] if you are not using a filter. The pump will alarm when more than 2.0 mL of air is detected.

A confirmation screen appears for all choices.

```
CHANGE AIR ALARM
FROM HIGH
TO OFF?
YES OR NO
```

Press [YES/ENTER] to confirm the change. Press [NO] to keep the current setting and return to the stop mode.

Function 5: Set Clock

The pump clock keeps time just as a typical clock does. The clock has a separate, internal battery that powers the clock continuously, whether the pump is turned on or off.

The correct time and date should be confirmed, and if necessary, adjusted, before the pump is used.

Remember: The pump's clock must be reset when Daylight Savings Time changes or if the pump is moved across time zones. If this is not done, the time notations on the program history will be incorrect and time-based deliveries will be off schedule.

Displaying the Time and Date

The current time and date can be displayed in the stop mode (the following is an example only).

```
TIME IS  9:40 AM
SAT AUG 3, 96
```

Press and release the [YES/ENTER] then immediately press and hold the [1] key. When the [1] key is released, the pump returns to the stop mode.

Setting the Clock

Note: The pump's clock cannot be changed while an intermittent or variable time delivery is in progress.

To change the date or time, place the pump in the stop mode, then press the [OPTIONS] key to display the Options Menu, and press the [5] key to access the Set Clock Menu.

```
SET CLOCK TYPE
1 SELECT 12 HOUR
2 SELECT 24 HOUR
```

Press [1] to select a 12-hour clock (A.M. and P.M.), or press [2] to select a 24-hour clock (1:00 P.M. = 13:00, etc.).

```
USE ARROW KEYS
TO SET WEEKDAY
SAT, AUG 3, 96
ENTER WHEN DONE
```

The pump cycles through a series of screens that request the following: weekday, month, day, and year.

Use the arrow keys to scroll the weekday and month choices. Use the numeric keys to select the day and year. Press [YES/ENTER] to accept each item.

USE NUMERIC KEYS
TO SET THE TIME
XX:XX XM
ENTER WHEN DONE

The pump shows the current time (AM or PM is shown for the 12-hour clock). If required, use the numeric keys to set the time and the arrow keys to select AM or PM. Press [YES/ENTER] to accept.

The revised setting appears on the display for confirmation. If correct, press [YES/ENTER] to accept, or press [BACK-UP] to correct an entry.

Function 6: Print

The history, current program parameters, speed protocols, and alarms can be printed or downloaded to file by connecting the pump to a printer or personal computer (PC).

Before accessing the Print Menu, connect the Abbott AIM Plus to a printer or PC as described in the following sections.

After the pump is connected, press the [OPTIONS] key to display the Options Menu and press the [6] key to access the Print Menu.

1 PRINT HISTORY
2 PRINT PROGRAM
3 PRINT PROTOCOL
4 PRINT ALARMS

Press the appropriate number for the type of information desired.

After the printing or downloading is complete, the pump returns to the mode it was in when [OPTIONS] was pressed.

□ Using a Printer

Two custom printer cables are available to connect the pump to a printer: List 13591 for use with the Seiko® DPU411 printer and List 13592 for use with the Kodak Diconix® 150+ and 180si printers. The two different cables are not interchangeable.

CAUTION: Printers should be operated on battery power when used with the Abbott AIM Plus. Do not connect the Abbott AIM AC power supply to a printer. For additional information regarding the printer in use, refer to the printer's operating manual.

To print, complete the following steps:

- Connect the printer to the pump.

Follow the manufacturer's instructions to connect the printer interface cable to the printer.

Insert the pin connector into the port on the pump.

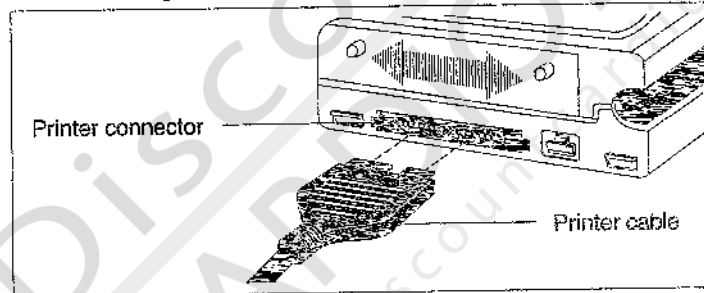

- Set the dipswitches.

For Seiko DPU411 or Kodak Diconix 150+ printers: Confirm that the dipswitch settings on the printer match the required settings shown below.

For the Kodak Diconix 180si printer: Generate the *Current Printer Settings* printout and confirm that they match the required settings listed on the following page.

Note: For all printers, changes to the dipswitch settings must be made before the printer is powered on.

- Load paper and place the printer ON LINE.

Seiko DPU411 Dipswitch Settings

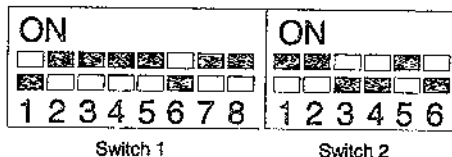

Kodak Diconix 150+ Dipswitch Settings

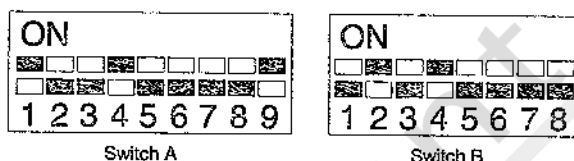

Kodak Diconix 180si Printer Settings

The required settings in bold type on the following page show those settings that must be changed from the default in order to print from the Abbott AIM Plus.

<i>(Sample default printout)</i>		Required Settings
Current Printer Settings		Epson FX-85
(1) Emulation	= SP Command Set	11 inches
(2) Page Length	= 11 inches	On
(3) Perforation Skip	= Off	USA
(4) Character Set	= USA	changes to Set 1
(5) Character Default	= Roman8	CR+LF
(6) Carriage Return	= CR	LF
(7) Line Feed	= LF+CR	Unidirectional
(8) Graphic Print Dir	= Unidirectional	Normal
(9) LF/Graphic/Pitch Mode	= Normal	RDY/BUSY
(10) Protocol	= RDY/BUSY	None
(11) Parity	= None	8 bits
(12) Data Length	= 8 bits	2400 (1)
(13) Baud Rates (Stop Bits)	= 9600 (1)	

□ Downloading to a PC

Custom printer cable List 13592 (used with Kodak printers) is available to connect the pump to a PC.

To download from the Abbott AIM Plus to a PC, complete the following steps:

- Install PC communications software (available from local sources) and confirm these settings:

Baud Rate (Stop Bits) = 2400 (1)
Parity = None
Data Length = 8 bits with 1 start bit and 1 stop bit
Carriage Return (+Line Feed) = CR+LF
Protocol = RDY/BUSY or NONE

- Use a serial interface cable or adapter (available from local sources) to connect the printer cable to the serial port of the PC.

Warning: Disconnect the pump from the patient before connecting the pump to a PC.
--

- Insert the printer cable pin connector into the port on the pump as shown on the previous page.

Function 7: Speed Protocol

If a protocol is used repeatedly, assigning a speed protocol number to that protocol allows the user to save that program for future use and, when desired, recall that program without entering the program information again. The Abbott AIM Plus holds up to nine speed protocols.

For instructions on printing a speed protocol go to page 8-15.

Note: Removing power or turning off the device has no effect on the air alarm setting for the current program or any of the speed protocols.

Lock Restrictions:

This function not available with a Full or Rate Change Lock.

This function is limited to speed protocols of the current therapy type with a Therapy Lock.

□ Assigning Speed Protocols

To assign a speed protocol number to the protocol in use, place the pump in the stop mode, press the [OPTIONS] key to display the Options Menu, and press the [7] key to access the Speed Protocol Menu.

1	ASSIGN
2	RECALL
3	REVIEW
4	DELETE

Press [1] to assign a protocol.

TO ASSIGN SPEED PROTOCOL, SELECT A NUMBER 1-9

Press [1] to [9] to assign and save the protocol with the speed access number.

TPN AND TAPER UP ASSIGNED TO SPEED PROTOCOL 1

A description of the protocol saved appears for several seconds, then the pump returns to the stop mode.

□ Recalling Speed Protocols

To recall a speed protocol, place the pump in the stop mode and press [OPTIONS]. If the pump has just been turned on, press [OPTIONS] at the Therapy Menu screen.

From the Options Menu, press the [7] key to access the Speed Protocol Menu.

1	ASSIGN
2	RECALL
3	REVIEW
4	DELETE

Press [2] to recall a speed protocol.

TO RECALL SPEED PROTOCOL, SELECT A NUMBER 1-9

Press [1] to [9] to select the desired speed protocol.

A program review is required. Press [↵] to review the program, then [YES/ENTER] to go to the stop mode.

Press [START] to begin delivery. For priming instructions go to page 2-11.

□ Reviewing Speed Protocols

To review an assigned speed protocol, place the pump in the stop mode, press the [OPTIONS] key to display the Options Menu, and press the [7] key to access the Speed Protocols Menu.

1	ASSIGN
2	RECALL
3	REVIEW
4	DELETE

Press [3] to review a protocol.

TO REVIEW SPEED PROTOCOL, SELECT A NUMBER 1-9

Press [1] to [9] to review the speed protocol. Use the arrow keys to scroll through the protocol.

If an unassigned number is pressed, SPEED PROTOCOL NOT ASSIGNED appears for several seconds.

When the review is complete, press [YES/ENTER] to place the pump in the stop mode.

Deleting Speed Protocols

To delete an assigned speed protocol, place the pump in the stop mode, press the [OPTIONS] key to display the Options Menu, and press the [7] key to access the Speed Protocol Menu.

1 ASSIGN
2 RECALL
3 REVIEW
4 DELETE

Press [4] to delete a protocol.

TO DELETE SPEED
PROTOCOL, SELECT
A NUMBER 1-9

Press [1] to [9] to delete the desired speed protocol.

PAIN MGMT SUBQ
DELETE SPEED
PROTOCOL 2?
YES OR NO

Press [YES/ENTER] to delete the protocol or [NO] to keep the protocol. The pump returns to the stop mode.

If an unassigned number is pressed, SPEED PROTOCOL NOT ASSIGNED appears for several seconds.

Function 8: Adjustments

You can adjust the sound level of the pump's beeper and the contrast between the text and the background of the display.

This function not available when the pump is in Full Lock.

Sound level adjustments apply only to the current protocol. When a new program is entered or a speed protocol is recalled, the sound level returns to the factory default. Display contrast adjustments apply until changed again.

Note: If the sound level is lowered from the default value, an alarm that is not responded to in one minute will raise the sound level back to the default value.

If no key is pressed within 10 seconds while the adjustments screens are displayed, the pump returns to the stop mode without changing the sound level or display contrast.

□ Adjusting the Sound Level

To adjust the sound level, place the pump in the stop mode, press the [OPTIONS] key to display the Options Menu, and press the [8] key to access the Adjustments Menu.

1 SOUND LEVEL
2 VARY CONTRAST

Press the [1] key.

- [] +
USE ↑ ↓ TO ADJUST
SOUND LEVEL
ENTER WHEN DONE

When the sound level adjustment screen is accessed, the pump sounds a continuous tone.

Press the [↓] key to shorten the bar on the top line of the display and reduce the sound level, or press the [↑] key to lengthen the bar on the top line of the display and increase the sound level.

Press the [CHANGE] key to return the sound level to the factory default.

□ **Varying the Contrast**

To vary the display contrast, place the pump in the stop mode, press the [OPTIONS] key to display the Options Menu, and press the [8] key to access the Adjustments Menu.

1 SOUND LEVEL
2 VARY CONTRAST

Press the [2] key.

USE ↑ ↓ TO VARY
DISPLAY CONTRAST
ENTER WHEN DONE

Press the [↓] key to reduce the display contrast, or press the [↑] key to increase the display contrast.

Press the [CHANGE] key to return the display contrast to the factory default.

Function 9: Alarm Log

To aid in troubleshooting, the Abbott AIM Plus logs all alarms in the order that they occur and allows you to display and print this information. The software versions of the main and safety microprocessors are at the top of this list for easy reference when calling Abbott Clinical Customer Support. The hotline telephone number is listed on page 9-1 and on the first page of this manual.

When displaying the log, alarms are listed by error code number only. When printing the log, alarms are listed by error code and the 12 character description; go to page 9-4, *Alarms*, for a description of each code.

□ Displaying the Alarm Log

To display the alarm log and software versions, place the pump in the stop mode, press the [OPTIONS] key to display the Options Menu, and press the [9] key to access the Alarm Log display.

VERSION NUMBER	
MAIN	n . nnn
SAFETY	n . nnn
USE	↓ FOR MORE

The software versions of the main and safety microprocessors are displayed at the top of the list. Use the arrow keys to move up and down the list. Press [BACK-UP] to return to the stop mode.

□ Printing the Alarm Log

To print the alarm log and software versions, first connect the pump to a printer or PC (for setup instructions refer to page 8-16, *Using a Printer*, or page 8-18, *Downloading to a PC*).

After the printer or PC is connected, place the pump in the stop mode, then press the [OPTIONS] key to display the Options Menu and press the [6] key to access the Print Menu.

1	PRINT HISTORY
2	PRINT PROGRAM
3	PRINT PROTOCOL
4	PRINT ALARMS

Press [4] to start printing or downloading.

9 Troubleshooting

This section contains information on audible and visual alarms that may occur with the Abbott AIM Plus.

CAUTION: If the pump does not perform as stated in this manual, stop using it immediately.

Customer Support

The healthcare professional should contact either an authorized Abbott representative or the Abbott Clinical Customer Support hotline, available **24 hours a day**, for consultation and technical assistance.

To return a pump for service, first contact Abbott Clinical Customer Support to receive a Returned Goods Authorization (RGA) number, then return the pump to Abbott AIS Technical Service.

Abbott Clinical Customer Support:

1-800-338-7867

Abbott AIS Technical Service
15330 Avenue of Science, Suite 100
San Diego, CA 92128

Alert Messages

Following are descriptions and remedies of alert messages.

Press the [HELP] key for information about an alert message. If necessary use the arrow keys to scroll through the message. Press the [BACK-UP] key to exit the help screen.

Abbott AIM Plus Alert Messages		
Message and Indicators	Condition	Remedy
PROGRAMMING INCOMPLETE Alarm LED flashes Beeping	Programming is not complete and no keys have been pressed for more than three minutes	Press any key to clear
START Alarm LED flashes Beeping	Programmed pump has remained in the stop mode for more than three minutes	Press [SILENCE] to mute for three minutes Press [START] to begin protocol or move ON/OFF switch to OFF position to turn pump off
CHECK PRINTER Alarm LED lights Beeping Delivery continues	Pump to printer connection has been disrupted or print function has been selected without the printer connected	Press [SILENCE] key to mute for two minutes Check printer cable connections to pump and printer Check printer for malfunctions according to manufacturer's recommendations
ALMOST EMPTY Beeping Delivery continues	Delivery will complete in 30 minutes or less For bolus only program, delivery will complete during next bolus delivery	Press [SILENCE] to mute for ten minutes <i>Note:</i> This alert does not occur with TPN, Intermittent, or Variable Time protocols

Abbott AIM Plus Alert Messages		
Message and Indicators	Condition	Remedy
<p>EMPTY CONTAINER</p> <p>Alarm LED flashes Beeping</p>	<p>Pump has delivered container size programmed</p> <p>If bolus delivery is in progress when alarm occurs, bolus delivery can be completed or deleted as desired after New Container is chosen</p>	<p>Press [SILENCE] to mute for two minutes</p> <p>Press [STOP]</p> <p>Use New Container function to repeat current program; go to page 8-2 for instructions</p>
<p>END OF INFUSION</p> <p>Without KVO: Alarm LED flashes Beeping</p> <p>With KVO: 5 beeps at time of alarm, and every 15 min. thereafter</p>	<p>For TPN protocols: Pump has delivered TPN volume or completed auto taper down</p> <p>For Intermittent protocols: Pump has reached end of off cycle of last dose delivered.</p>	<p>Press [SILENCE] to mute for two minutes (periodic beeping during KVO delivery cannot be muted)</p> <p>Press [STOP] to place pump in stop mode</p>

Alarms

Following are descriptions, causes, and remedies of alarm conditions.

The alarm log and pump software versions can be reviewed and printed through the Alarm Log feature of the Options Menu (refer to page 8-24 for instructions).

Press the [HELP] key for information about a current alarm condition. If necessary use the arrow keys to scroll through the message. Press the [BACK-UP] key to exit the help screen.

Abbott AIM Plus Alarms: Error codes 1 - 7			
#	Message and Indicators	Source of Error	Remedy
1	AIR-IN-LINE or 2 mL AIR DETECTED Alarm LED lights Beeping Delivery stopped	Air has been detected in line	Press [SILENCE] to mute for one minute Press [STOP] Disconnect patient from set and follow appropriate prime procedure (Note: Priming not available in Full Lock)
2	CHECK CARTRIDGE Alarm LED lights Beeping Delivery does not begin	Cartridge is not installed or improperly installed	Press [SILENCE] to mute for one minute Check that latch is closed Check cartridge installation: close slide clamp, remove cartridge, realign dot in red circle on cartridge, and reinsert cartridge in pump

Abbott AIM Plus Alarms: Error codes 1 - 7			
#	Message and Indicators	Source of Error	Remedy
3	<p>OCCLUSION</p> <p>Alarm LED lights Beeping Delivery stopped</p>	<p>Blockage in the line between pump and patient, or cartridge is improperly installed</p>	<p>Press [SILENCE] to mute for one minute</p> <p>Press [STOP]</p> <p>Check that latch is closed</p> <p>Check for occlusion and correct problem</p> <p>Check cartridge installation: close slide clamp, remove cartridge, realign dot in red circle on cartridge, and reinsert cartridge in pump</p>
4	<p>PRIME OVERUSE</p> <p>Alarm LED lights Continuous tone Delivery stopped</p>	<p>Pump was primed for more than 2 minutes</p>	<p>Press [SILENCE] to clear</p>
5	<p>USING BATTERIES</p> <p>Beeps every minute Delivery continues</p>	<p>Pump is now powered on batteries</p>	<p>Press [START], [STOP], or [SILENCE] to clear</p> <p>Check for secure AC connection and restore AC power if necessary</p>
6	<p>LOW BATTERIES</p> <p>Beeping once per minute Delivery continues until POWER LOSS alarm condition is reached</p>	<p>Batteries are nearing depletion</p>	<p>Press [STOP], then power off</p> <p>Replace batteries, or connect pump to AC power, then power on</p>

Abbott AIM Plus Alarms: Error codes 1 - 7			
#	Message and Indicators	Source of Error	Remedy
7	POWER LOSS Continuous tone Delivery stopped Program saved Pump shuts down	AC adapter disconnected, batteries removed, or batteries are dead	Power off to mute Replace batteries, or connect pump to AC power

Error codes 8 - 16 are displayed with the code number and screen message.

```

ERROR DETECTED
nnn-xxxxxxxxxxxx
PRESS START
TO RE-TRY

```

Alarm LED lights and beeping sounds.

Remedy for Error Codes 8 - 16: Press [START] to clear alarm and return to mode pump was in when alarm occurred. If message is not cleared by pressing [START] contact Abbott Customer Support.

Abbott AIM Plus Alarm Messages: Error codes 8 - 16		
#	Message and Indicators	Source of Error
8	MOTOR SPEED	Motor speed off by more than 20%
9	NOT PUMPING	No encoder signals when running
10	NO OFF CYCLE	Motor still on at start of next cycle
11	HIGH CURRENT	Excessive motor current when running (100ma)
12	NOT PRIMING	No encoder signals while priming
13	HIGH CURRENT	Excessive motor current when priming (100ma)
14	SPEED CALC.	Motor Speed - Voltage/Current error
15	NO SPEED CK	MSV calculations not done
16	BACK-UP LOW	Lithium backup battery is low

Error codes 100 - 143 are displayed with the code number and screen message.

ERROR DETECTED nnn-xxxxxxxxxxxxx POWER OFF, THEN ON TO RETRY

Alarm LED lights and continuous tone sounds.

Remedy for Error Codes 100 - 143: Use the power switch to power off the pump, then power on again. If the pump completes the self-test after power off and on, the error has been cleared and the pump can continue to be used. If the error message returns contact Abbott Customer Support.

Abbott AIM Plus Alarms: Error codes 100 - 143		
#	Message and Indicators	Source of Error
100	STUCK KEY	Stuck key detected
101	RTI OVERLAP	RTI did not complete before the next RTI
102	IRQ OVERLAP	IRQ did not complete before the next IRQ
103	XIRQ OVERLAP	XIRQ did not complete before the next XIRQ
104	CCW COUNTER	Counter-clockwise encoder interrupt did not complete before next interrupt
105	CW COUNTER	Clockwise encoder interrupt did not complete before next interrupt
106	TIMER COUNT	Timer overflow interrupt did not complete before next interrupt
107	AC POWER	AC adapter supplying more than 9.0v
108	MAIN ROM CKS	ROM checksum error
109	MAIN RAM TST	RAM integrity error
110	MAIN STACK	Stack overflow
111	MAIN CPU TST	Background CPU test failed
112	NO MOTOR CTL	Motor power up test failure
113	NO RAM TEST	RAM check did not complete
114	PROGRAM CRC	CRC error in program
115	RUN TIME CRC	CRC error in run time parameters

Abbott AIM Plus Alarms: Error codes 100 - 143		
#	Message and Indicators	Source of Error
116	SPD PROT CRC	CRC error in protocol
117	CLR TIME CRC	CRC error - cleared times
118	MOTOR ON ERR	Motor turning when it should be off
119	MOT VOLT ERR	Motor voltage present when it should be off
120	NVRAM WR ERR	Error writing to internal NVRAM
121	BAD CRC TYPE	Invalid type in ram_crc()
122	STATE ERR	Invalid main_state value
123	NO BACK-UP	Lithium backup battery is dead
124	RAM ERR LOG	RAM error log checksum error
125	MOT NOT CAL.	Motor not calibrated
126	TIME BASE	Oscillator and real time clock don't agree
127	SFTY SW VER#	6805 version number not what is expected
128	SFTY ROM CRC	ROM checksum error
129	SFTY RAM TST	RAM Integrity error
130	SAFETY STACK	Stack overflow
131	SFTY CPU TST	Background CPU test failed
132	SFTY MOT ON	6805 detected motor turning when it should be off
133	SFTY MOT OFF	6805 no encoder signals when the motor should be on
134	SFTY MOT SPD	6805 motor speed is off by more than 20%
135	SPI CHECKSUM	SPI packet checksum error
136	SPI ASCII	SPI packet non-ASCII error
137	SPI TRANSFER	SPI packet slave transfer error
138	SPI WAITING	SPI packet not-waiting error
139	SPI PROCESS	SPI packet not-processing error
140	SPI ENDTRANS	SPI packet not-end-transmission error

Abbott AIM Plus Alarms: Error codes 100 - 143		
#	Message and Indicators	Source of Error
141	SPI POST ERR	SPI packet POST error
142	CONFIG REG	CONFIG register does not equal 6D
143	HRDWRE RESET	Hardware watchdog reset the pump electronics

Error code 999 is displayed if more than five self-tests have failed in one minute.

ERROR DETECTED 999-HIGH ERR CNT CONTACT CUSTOMER SUPPORT

Alarm LED lights and beeping sounds.

Remedy: Contact Abbott Customer Support.

Troubleshooting Problems and Solutions

Following are possible functional problems that may occur. Attempt all noninvasive solutions before returning the pump for repair.

Symptoms	Possible Causes	Corrective Actions
No pump display upon installing batteries or display scrambled and beeper pattern is not normal	a) Batteries may be dead or not fully charged	a) Replace all four batteries
	b) Mechanical malfunction	b) Return pump for service
	c) Battery installed with incorrect polarity	c) Re-install batteries with correct polarity
No display or scrambled display on power-up, but beeper pattern appears normal	Mechanical malfunction	Return pump for service
One or more keys on keypad inoperative	a) Keypad may be locked	a) Unlock keypad
Typical keypad failure causes one entire row or column to be inoperative	b) Mechanical malfunction	b) Return pump for service
Beeper inoperative, but display appears normal	Mechanical malfunction	Return pump for service
Motor won't turn or turns at wrong speed	Mechanical malfunction	Return pump for service
Clock does not keep accurate time	Internal battery or mechanical malfunction	Return pump for service
Short battery life	a) Battery voltage may be low	a) Install all new, fresh batteries
	b) Rechargeable AA batteries in use	b) Rechargeable AA batteries not recommended
	c) Mechanical malfunction	c) Return pump for service
OCCLUSION or CHECK CARTRIDGE alarm does not activate when occlusion is present	Mechanical malfunction	Return pump for service

Symptoms	Possible Causes	Corrective Actions
OCCLUSION or CHECK CARTRIDGE alarm stays on	a) Cartridge may not be fully installed	a) Check to assure cartridge is firmly seated in motor frame and that the latch is fully closed and flush with back case
	b) No cartridge installed or cartridge may be faulty	b) Install new set
	c) Optics may be dirty	c) Clean optics windows as directed in <i>Section 10, Maintenance</i>
	d) Mechanical malfunction	d) Return pump for service
AIR-IN-LINE alarm stays on even when air is not present in sensing chamber of cartridge.	Mechanical malfunction	Return pump for service
AIR-IN-LINE alarm does not come on when air is present in sensing chamber of tubing.	a) Air sensitivity alarm may be disarmed	a) Place the pump in the stop mode and check air sensitivity setting. Revise setting if necessary (refer to page 8-13)
	b) Optics windows may be dirty	b) Clean optics windows as directed in <i>Section 10, Maintenance</i>
	c) Cartridge may be faulty	c) Install new cartridge
	d) Mechanical malfunction	d) Return pump for service

9-12

Abbott AIM Plus

Notes:



10

Maintenance

This section contains information about charging the battery pack, and storing, cleaning and repairing the pump.

Battery Pack Recharging

Use the AC power supply to recharge the battery pack.

CAUTION: Use only Abbott AC Power Supply List 13586 to charge the battery pack.

To recharge the battery pack, complete the following steps:

- Remove the battery pack from the pump.
- Plug the AC power supply pin connector into the port on the bottom of the battery pack.
- Plug the AC power supply into a standard wall outlet (grounded 110 volt). The amber LED on the pack lights to indicate it is plugged in to AC power.

The light will not go out when charging is complete.

- Leave the pack connected to AC power supply at least 14 hours to completely recharge the pack.
- **Do not charge the battery pack longer than 72 hours as this may damage the battery cells.**

Storing the Pump

Store the Abbott AIM Plus in a cool, dry place. Remove the disposable batteries or the battery pack before storing the pump.

Program and event history are protected in the software memory for at least one year when power is removed from the pump.

Cleaning and Disinfecting the Pump

Establish a routine schedule for cleaning the pump to keep the case exterior and cartridge channel free of contamination.

CAUTION: To avoid mechanical or electronic damage, do not immerse pump in any fluids or cleaning solutions.

Some cleaning and sanitizing compounds may slowly degrade components made from some plastic materials. Do not use compounds containing combinations of isopropyl alcohol and dimethyl benzyl ammonium chloride.

Do not sterilize by heat, steam, ETO, or radiation. Apply disinfectants to the outside surface of the pump only. Do not use abrasive cleaners or materials on the pump. Using abrasive cleaners or cleaning solutions not recommended by Abbott Laboratories may result in product damage.

To avoid pump damage, cleaning solutions should be used only as directed in the table on the following page. The disinfecting properties of cleaning solutions vary; consult the manufacturer for specific information.

Never use sharp objects such as pens, pencils, fingernails, paper clips, needles, etc., to clean the pump.

Recommended Cleaning Solutions

The pump is not affected by the recommended cleaning solutions.

The Abbott LifeCare® Germicidal Towelette (List 11937) is a pre-moistened wipe containing a quaternary ammonium chloride germicidal detergent. The towelette has been found to be effective against a broad spectrum of bacterial, fungal, and viral pathogens. The towelette complies with the recommendations of the CDC and OSHA. For additional information on the LifeCare Germicidal Towelette, call 1-800-222-6883.

Note: Not all cleaning solutions are disinfectants. Check product labeling.

Cleaning Solution	Manufacturer	Preparation
LifeCare [®] Germicidal Towelette	Manufactured for Abbott Laboratories	Per manufacturer's recommendation; use undiluted
Super Edisonite [®]	S. M. Edison Chemical Co.	Per manufacturer's recommendation
Vesphene [®] II se	Calgon Vestal Laboratories	Per manufacturer's recommendation
Manu-Klenz [®]	Calgon Vestal Laboratories	Per manufacturer's recommendation
Formula C [™]	Diversey Corp.	Per manufacturer's recommendation
Household bleach	Various	Per healthcare facility procedures; do not exceed one part bleach in ten parts water

Cleaning the Pump Case

To clean the pump, complete the following steps:

- Turn off the pump.
- Clean the exposed surfaces of the pump with a LifeCare Germicidal Towelette or soft, lint-free cloth dampened with the appropriate cleaning solution.
- Wipe the solution from the pump surface with a moistened cloth.
- Dry the pump after cleaning.

Cleaning the Cartridge Channel

The area containing the optics surfaces, located in the cartridge channel, should be cleaned on a regular basis.

CAUTION: If the optics surfaces are not kept clean and free of detergent film, the pump's ability to detect air in the tubing or occlusion in the tubing between the pump and the patient may be impaired.

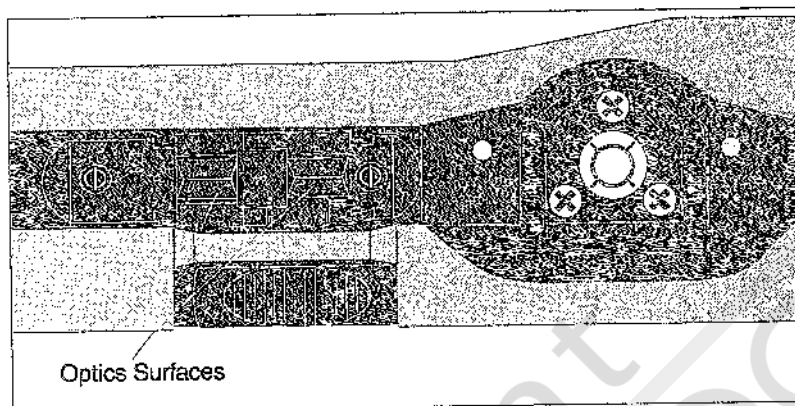

To clean the pump optics:

- Remove the cartridge, if installed.
- Use a moist cotton swab to clean the pump optics and cartridge channel.
- Dry the pump optics and cartridge channel after cleaning. Assure that the optics surfaces are free of detergent film.

Repair

The Abbott AIM Plus has no user-serviceable components, with the exception of disposable batteries.

Homecare Customers: Call your healthcare professional or homecare company regarding any required service or repairs. Do not attempt to repair the pump for any reason.

The Abbott AIM Plus is covered by a manufacturer's warranty for two years after purchase. During this time, opening the pump case for any reason voids this warranty. Refer to *Section 12, Warranty*, for details.

Refer all service to qualified and trained personnel only. An *Abbott AIM Plus Technical Service Manual* is available to qualified service personnel.

11 Specifications

Pump Specifications	
Physical	
Dimensions:	Height: 6.0 in. (15.2 cm) Width: 4.0 in. (10.2 cm) Depth: 1.5 in. (3.8 cm)
Weight:	Approximately one pound (0.45 kg)
Transport & Storage Environment	
Ambient Temperatures:	-20° to +60° C
Relative Humidity:	10% to 90%
Atmospheric Pressure:	0 - 10,000 ft. (0 - 3,000 m) equiv. pressure
Operating Environment	
Ambient Temperatures:	+10° to +40° C
Power Sources	
AC Mains:	Wall plug-in AC power supply; 12 ft. (3.6 m) cord; molded plug Input: 120 VAC, 60 Hz, 0.06 A Output: 8 VDC, 0.4 A
Battery:	Four AA alkaline batteries
Battery Pack:	Rechargeable using AC power supply
Power Capacity	On four AA alkaline batteries or battery pack, at least 3400 mL at rates above 50 mL/hr and at least four days at rates below 10 mL/hr
Pump Mechanism	Dual micro-processor controlled eccentric-rotor peristaltic motor
Memory Protection	Current program and 512 event history log protected by internal battery-backed memory for at least one year after power is removed
Operating Controls	One 4-key and one 18-key keypad; ON/OFF switch on side of pump; bolus and AC power supply jacks on side pump; bolus button on top of pump

External Power LED	Green LED marked with plug icon lights when pump connected to AC power (mains)
Alarm LED	Red LED marked with alarm icon lights during alarm conditions
Display	Four-line-by-sixteen-character alphanumeric liquid crystal display (LCD), backlit
Contrast:	Adjustable display contrast
Backlight on AC:	Continuous
Backlight on Batteries:	Continuous during programming, program review, and history display; otherwise activated by keypress
Real Time Clock	Accuracy of ± 1 minute per month or better
Print Function	
Port & Interface:	RS232C serial interface port, isolated circuit
Printers:	Seiko DPU411, or Kodak Diconix 150+ or 180si
System Accuracy	$\pm 5\%$ nominal
Air Sensitivity	
HIGH:	Pump alarms at approximately 100 μL of air Note: When infusing emulsions, pump may require air bubble larger than 100 μL to cause alarm
LOW:	Pump alarms at approximately 300 μL of air
OFF:	If user has selected the option for air-eliminating filter in use, there is no alarm; if option for no air-eliminating filter in use selected, pump alarms at approximately 2 mL of air
Pump Self-Tests & Safety Features	Self-test performed when power switch activated; diagnostic routine, including motor speed and air detection monitoring, repeated continuously while pump powered on; self-test failure generates error detected alarm (refer to <i>Section 9, Troubleshooting</i>) Error and alarm conditions are indicated by both audible and visual alarms; delivery in progress is stopped (if appropriate)

Program Specifications

The following table provides minimum and maximum values of program parameters for each delivery mode.

Delivery Mode Parameters	Minimum value	Maximum value
TPN		
Volume	1 mL	9600 mL
Total Infusion Time	1 minute	24 hours
Taper Up/Down Times	1 minute	3 hours
KVO Rate	1.0 mL/hr	5.0 mL/hr
KVO Time	1 minute	24 hours
Container Size	TPN plus KVO volume	9999 mL
Pain Management		
Concentration	0.1 mg/mL, or 1 µg/mL	50.0 mg/mL, or 1000 µg/mL
Delivery Rate	0.0 mL/hr continuous + bolus 0.1 mL/hr continuous only	5.0 mL/hr subcutaneous, or 25.0 mL/hr epidural, or intravenous
	0.0 mg/hr or 0 µg/hr continuous + bolus 0.1 mg/hr, or 1 µg/hr, or concentration x 0.1 mL/hr continuous only	1250.0 mg/hr, or 25000 µg/hr
Loading and Bolus Doses	0.0 mL continuous + bolus 0.1 mL bolus only	5.0 mL subcutaneous, or 25.0 mL epidural, or intravenous
	0.0 mg or 0 µg continuous + bolus 0.1 mg, or 1 µg, or concentration x 0.1 mL continuous only	1250.0 mg, or 25000 µg, or concentration x max. volume in mL

Delivery Mode Parameters	Minimum value	Maximum value
Loading and Bolus Doses Delivery Rate	approximately 125 mL/hr	
Bolus Lockout	5 minutes	999 minutes
Four Hour Dose Limit	4 x delivery rate (bolus only delivery is one bolus dose)	400.0 mL intravenous or epidural, or 20.0 mL subcutaneous, or mg or µg equivalent
Boluses Per Hour Limit	1 per hour	12 per hour
Container Size	0.1 mL	9999.9 mL
	0.1 mg, or 1 µg, or concentration x 0.1 mL	9999.9 mg, or 999999 µg
Intermittent Delivery		
Concentration	0.1 mg/mL, or 1 µg/mL	1000.0 mg/mL, or 1000 µg/mL
Dose Amount	0.1 mL	9600.0 mL
	0.1 mg, or 1 µg, or concentration x 0.1 mL	9900.0 mg, or 999900 µg
Infusion Time Per Dose	1 minute, or dose amount ÷ 400.0 mL/hr)	24 hours
Dose Frequency	1 minute	96 hours
Number of Doses in Container	1 dose	999 doses, or max. volume ÷ dose amount
KVO Rate	0.1 mL/hr	5.0 mL/hr
	0.1 mg/hr, or 1 µg/hr, or concentration x 0.1 mL/hr	5000.0 mg/hr, or 5000 µg/hr, or concentration x 5.0 mL/hr

Delivery Mode Parameters	Minimum value	Maximum value
Bolus Dose	0.1 mL	25.0 mL
	0.1 mg, or 1 µg, or concentration x 0.1 mL	9900.0 mg, or 25000 µg, or concentration x 25.0 mL
Bolus Dose Delivery Rate	approximately 400 mL/hr	
Bolus Lockout	5 minutes	999 minutes
KVO Rate	0.1 mL/hr	5.0 mL/hr
	0.1 mg/hr, or 1 µg/hr, or concentration x 0.1 mL/hr	5000.0 mg/hr, or 5000 µg/hr, or concentration x 5.0 mL/hr
Container Size	0.1 mL	9999.9 mL
	0.1 mg, or 1 µg, or concentration x 0.1 mL	9900.0 mg, or 999900 µg
Continuous Delivery		
Concentration	0.1 mg/mL, or 1 µg/mL	1000.0 mg/mL, or 1000 µg/mL
Rate	0.1 mL/hr	400.0 mL/hr
	0.1 mg/hr, or 1 µg/hr, or concentration x 0.1 mL/hr	9900.0 mg/hr, or 400000 µg/hr, or concentration x 400.0 mL/hr
Container Size	0.1 mL	9999.9 mL
	0.1 mg, or 1 µg, or concentration x 0.1 mL	9900.0 mg, or 999900 µg

12

Warranty

The Abbott AIM Plus pump has been carefully manufactured using high-quality components. It is warranted to be free from defects in material and workmanship for a period of two years from the date of purchase under normal use and service. The warranty on the optional battery pack and other accessories is limited to 90 days.

On return to Abbott Laboratories, the pump will be repaired or replaced within the terms of this warranty. Material returned to Abbott Laboratories must be properly packaged and sent freight prepaid.

This warranty shall not apply if the pump has been repaired by anyone other than Abbott Laboratories qualified service personnel, or altered in any way which, in Abbott Laboratories' judgment, affects its stability or reliability, or if the serial number has been altered, effaced, or removed.

THIS WARRANTY IS IN LIEU OF ALL OTHER WARRANTIES, EXPRESS OR IMPLIED.

Battery Installation

Remove battery door and verify battery contacts are free of residue.

Install four AA alkaline batteries. Slide power switch to ON and verify pump powers on.

Slide power switch to OFF position and remove batteries.

AC Connection

Connect AC power supply to power jack on left side of pump. Slide power switch ON and verify pump powers on.

Verify plug symbol LED on front case illuminates.

Disconnect AC power supply and insert all four batteries.

Operation Verification

Equipment:

- Abbott AIM Plus with batteries installed
- Abbott Quick-Load™ pump set
- Reservoir with at least 15 mL of water
- 15 mL or larger calibrated burette

Note: Certain flow rate accuracy instruments may yield inconsistent and/or erroneous results. Use volumetric or gravimetric test methods.

Self-Test

Slide the power switch to the ON position.

Verify that pump immediately sounds a tone, briefly flashes alarm and AC power LED's, and proceeds with power on self-test.

UNIT SELF-TEST
IN PROGRESS
TIME IS XX:XXM
XXX,XXX X, XX

No user response is required.

Verify time and date displayed are correct.

Because batteries are the only power source, the following display appears.

USING BATTERIES

ENTER TO CONFIRM

Press [YES/ENTER].

If the previous program was saved in the pump's memory, it is shown on the display.

CURRENT THERAPY:
XXXXXXXXXXXXXXXXXX
USE CURRENT?
YES OR NO

Press [NO] to clear the program.

CLEAR
THE HISTORY?

YES OR NO

Press [YES/ENTER] to clear the history.

CLEARING HISTORY and CLEARING PROGRAM messages will display briefly, then the therapy menu appears.

Program Entry

If necessary, set the clock by pressing [OPTIONS], then [5] to select Set Clock Type. Follow the instructions on the display to enter the time and date.

1 TPN
2 PAIN MANAGEMENT
3 INTERMITTENT
USE ↓ FOR MORE

Press [2] to select pain management therapy.

1 INTRAVENOUS
2 EPIDURAL
3 SUBCUTANEOUS

Press [2] to select epidural delivery.

1 CONTINUOUS
2 BOLUS ONLY
3 CONT. + BOLUS

Press [3] to select continuous with bolus.

1 SELECT mg/mL
2 SELECT µg/mL
3 SELECT mL

Press [3] to select mL.

SET RATE
0.0 mL/hr
ENTER WHEN DONE

Press each numeric key and verify the correct number displays.

Press [9] [8] [7] [6] [▲] [5] [CHANGE] (9876.5)
Press [4] [3] [2] [1] [▲] [0] [CHANGE] (4321.0)

Press [2] [5] [ENTER] to select a 25 mL/hr rate.

PROGRAM A
LOADING DOSE?
YES OR NO

Press [NO] to skip the loading dose.

SET BOLUS DOSE
0.0 mL
ENTER WHEN DONE

Press [1] [0] [YES/ENTER] to select a bolus dose of 10 mL.

BOLUS LOCKOUT
0 MINUTES
ENTER WHEN DONE

Press [5] [YES/ENTER] to select a 5 minute lockout.

DOSE LIMIT
1 4 HOUR LIMIT
2 # BOLUSES/HOUR
3 NO DOSE LIMIT

Press [3] to skip the dose limit option.

CONTAINER SIZE
0.0 mL
ENTER WHEN DONE

Press [5] [0] [YES/ENTER] to select a 50 mL container size.

AIR SENSITIVITY
1 HIGH
2 LOW
3 AIR ALARM OFF

Press [1] to select the high sensitivity setting.

PROGRAM
REVIEW
USE ↓ FOR MORE

Use arrow keys to review program. When review is complete, press [YES/ENTER].

0.0 mL INFUSED
RATE 25.0 mL/hr
PRESS START
TO INFUSE

SAVING PROGRAM briefly appears, then the pump enters the stop mode.

Occlusion Alarm

Install primed Abbott Quick-Load™ set in pump.

Place proximal (upstream) end of tubing in reservoir containing water and place distal (downstream) end into burette.

Occlude distal end of set.

Press [START] to begin delivery.

0.0 mL INFUSED
RATE 25.0 mL/hr
PRESS START
TO INFUSE

X.X mL INFUSED
RATE 25.0 mL/hr

While continuous delivery is in progress, press the bolus button on top of the pump to begin a bolus delivery.

X.X mL INFUSED
RATE 125.0 mL/hr
BOLUS DELIVERY

Verify BOLUS DELIVERY appears on display and that the delivery rate increases to 125 mL/hr. Wait for occlusion alarm to occur.

X.X mL INFUSED
RATE 125.0 mL/hr
BOLUS DELIVERY
OCCLUSION

Verify audible alarm sounds and OCCLUSION flashes on display.

Press [SILENCE] to silence alarm and return to stop mode.

Remove occlusion to clear alarm.

Air In Line Alarm

Press [START], then [YES/ENTER] to resume bolus delivery.

Disconnect proximal end of tubing from reservoir and allow air to fill tubing.

X.X mL INFUSED
 RATE 125.0 mL/hr
 BOLUS DELIVERY
 AIR IN LINE

Verify audible alarm sounds and AIR IN LINE flashes on display.

Press [SILENCE] to silence alarm, then [STOP] to return to stop mode.

Priming Function

Reconnect proximal end of tubing to reservoir.

Note: Air must be cleared from line before proceeding or inaccurate results may occur.

x.x mL INFUSED
 RATE 25.0 mL/hr
 PRESS START
 TO INFUSE

Press [PRIME].

PRIME THE SET?

Press [YES/ENTER].

YES OR NO

DISCONNECT
 THE LINE FROM
 THE PATIENT NOW

No response required. This message displays for several seconds.

TO PRIME,
 PRESS AND HOLD
 THE 'PRIME' KEY

Press and hold [PRIME].

PRIMING

The primed volume accrues while the key is held.

X.X mL

Release [PRIME] when the line is clear.

PRIME COMPLETE?

Press [YES/ENTER] if priming is finished or [NO] to continue priming.

YES OR NO

When [YES/ENTER] is pressed the pump enters the stop mode.

Installation Test

13-7

X.X mL INFUSED
RATE 25.0 mL/hr
PRESS START
TO INFUSE

Press [START].

COMPLETE BOLUS
NOW?
YES OR NO

Press [NO] to skip the remainder of the bolus dose.

Press [STOP] to return to the stop mode.

Delivery Test

Set burette level to zero.

X.X mL INFUSED
RATE 25.0 mL/hr
PRESS START
TO INFUSE

Press [YES/ENTER] immediately followed by [0] to program a loading dose.

PROGRAM A
LOADING DOSE?
YES OR NO

Press [YES/ENTER].

SET LOADING DOSE
0.0 mL
ENTER WHEN DONE

Press [1][0][YES/ENTER] to select a loading dose of 10 mL.

DELIVER THE
LOADING DOSE
NOW?
YES OR NO

Press [YES/ENTER].

SAVING PROGRAM displays briefly.

X.X mL INFUSED
DELIVERING
LOADING DOSE

Amount infused accrues on the display during infusion.

When loading dose is complete, pump enters the stop mode.

Verify total amount of fluid in the burette is between 9.5 and 10.5 mL.

Note: The amount infused shown on the display will be more than 10.0 mL due to previous bolus delivery.

Clear Test History & Program

X.X mL INFUSED
RATE 25.0 mL/hr
PRESS START
TO INFUSE

Press [OPTIONS].

1 REVIEW PROGRAM
2 HISTORY
3 KEYPAD LOCK
USE ↓ FOR MORE

Press [2] to access the History Menu.

1 SHOW HISTORY
2 PRINT HISTORY
3 CLEAR HISTORY

Press [3] to select Clear History.

CLEARING HISTORY displays briefly, then the pump returns to the stop mode.

X.X mL INFUSED
RATE 25.0 mL/hr
PRESS START
TO INFUSE

Press [CHANGE].

1 REVIEW/RESUME
2 NEW CONTAINER
3 NEW PROGRAM
4 CHANGE PROGRAM

Press [3] to select New Program.

CLEARING PROGRAM displays briefly, then the therapy menu appears.

Slide power switch to OFF position and remove batteries.

Abbott AIM® Plus Installation Test Record

Serial No:		
Tested By:		
Date:		
Comments:		
Pass	Fail	Check each item below to indicate verification.
		<i>Physical Inspection</i>
<input type="checkbox"/>	<input type="checkbox"/>	Case & Keypad
<input type="checkbox"/>	<input type="checkbox"/>	Motor Frame, Latch, & Optics
<input type="checkbox"/>	<input type="checkbox"/>	Battery Installation
<input type="checkbox"/>	<input type="checkbox"/>	AC Connection
		<i>Operation Verification</i>
<input type="checkbox"/>	<input type="checkbox"/>	Self-Test
<input type="checkbox"/>	<input type="checkbox"/>	Program Entry
<input type="checkbox"/>	<input type="checkbox"/>	Occlusion Alarm
<input type="checkbox"/>	<input type="checkbox"/>	Air In Line Alarm
<input type="checkbox"/>	<input type="checkbox"/>	Priming Function
<input type="checkbox"/>	<input type="checkbox"/>	Delivery Test Total fluid _____ (9.5 - 10.5 mL)
<input type="checkbox"/>	<input type="checkbox"/>	Clear Test History & Program
		<i>Additional Testing (write in as required)</i>
<input type="checkbox"/>	<input type="checkbox"/>	
<input type="checkbox"/>	<input type="checkbox"/>	
<input type="checkbox"/>	<input type="checkbox"/>	

430-800059-001 (Rev. 2/96)

WARNING: Federal (USA) law restricts this device to sale by or on the order of a physician or other licensed practitioner.

WARNING: Possible explosion hazard exists if used in the presence of flammable anesthetics.



CSA is a registered trademark of the Canadian Standards Association. The use of NRTL/C adjacent to the CSA mark indicates that the product has been certified by CSA to U.S. and Canadian standards. CSA has been accredited by the U.S. Occupational Safety and Health Administration (OSHA) as a Nationally Recognized Test Laboratory (NRTL).



Attention: Consult accompanying documents.

Abbott AIM Plus and LifeCare are registered trademarks of Abbott Laboratories. Quick-Load is a trademark of Abbott Laboratories.

Super Edisonite is a registered trademark of S.M. Edison Chemical Company. Vesphene II se and Manu-Klenz are registered trademarks of Calgon Vestal Laboratories. Formula C is a trademark of Diversey Corporation.

This document and the subject matter disclosed herein are proprietary information. Abbott Laboratories retains all the exclusive rights of dissemination, reproduction, manufacture and sale. Any party using this documentation accepts it in confidence, and agrees not to duplicate it in whole or in part nor disclose it to others without the written consent of Abbott Laboratories.

Copyright © 1996 Abbott Laboratories, Inc. All Rights Reserved
Printed in USA
Abbott Laboratories □ North Chicago □ Illinois 60064 USA



Discount

CARDIOLOGY

www.discountcardiology.com

www.discountcardiology.com